

Installation, Operation and Maintenance Manual

Please read and save these instructions. Read carefully before attempting to assemble, install, operate or maintain the product described. Protect yourself and others by observing all safety information. Failure to comply with instructions could result in personal injury and/or property damage! Retain instructions for future reference.

Model VSU

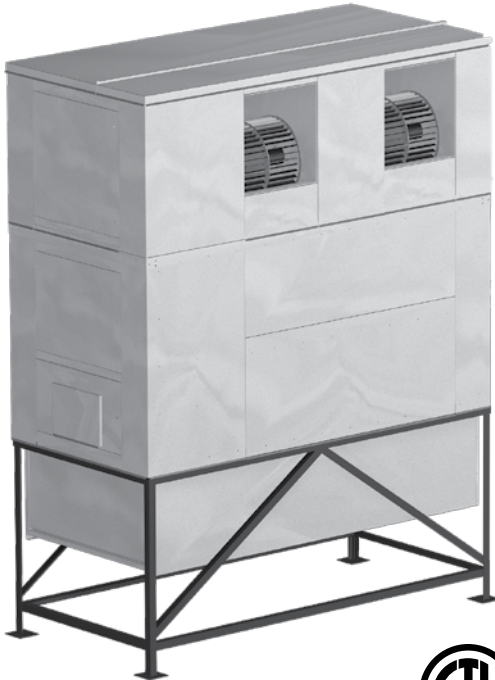

3. Motor must be securely and adequately grounded.
4. Do not spin fan wheel faster than the maximum cataloged fan rpm. Adjustments to fan speed significantly affects motor load. If the fan RPM is changed, the motor current should be checked to make sure it is not exceeding the motor nameplate amps.
5. Do not allow the power cable to kink or come in contact with oil, grease, hot surfaces, or chemicals. Replace cord immediately if damaged.
6. Verify that the power source is compatible with the equipment.
7. Never open blower access doors while the fan is running.

DANGER

Always disconnect power before working on or near a unit. Lock and tag the disconnect switch or breaker to prevent accidental power up.

CAUTION

When servicing the unit, motor may be hot enough to cause pain or injury. Allow motor to cool before servicing.

FOR YOUR SAFETY

If you smell gas:

1. Open windows.
2. Do not touch electrical switches.
3. Extinguish any open flame.
4. Immediately call your gas supplier.

FOR YOUR SAFETY

The use and storage of gasoline or other flammable vapors and liquids in open containers in the vicinity of this appliance is hazardous.

WARNING

Improper installation, adjustment, alteration, service or maintenance can cause property damage, injury or death. Read the installation, operating and maintenance instructions thoroughly before installing or servicing this equipment.

General Safety Information

Only qualified personnel should install this unit. Personnel should have a clear understanding of these instructions and should be aware of general safety precautions. Improper installation can result in electric shock, possible injury due to coming in contact with moving parts, as well as other potential hazards. Other considerations may be required if high winds or seismic activity are present. If more information is needed, contact a licensed professional engineer before moving forward.

1. Follow all local electrical and safety codes, as well as the National Electrical Code (NEC), the National Fire Protection Agency (NFPA), where applicable. Follow the Canadian Electric Code (CEC) in Canada.
2. The rotation of the wheel is critical. It must be free to rotate without striking or rubbing any stationary objects.

Receiving

Upon receiving the product check to make sure all items are accounted for by referencing the bill of lading to ensure all items were received. Inspect each crate for shipping damage before accepting delivery. Notify the carrier if any damage is noticed. The carrier will make notification on the delivery receipt acknowledging any damage to the product. All damage should be noted on all the copies of the bill of lading which is countersigned by the delivering carrier. A Carrier Inspection Report should be filled out by the carrier upon arrival and reported to the Traffic Department. If damaged upon arrival, file claim with carrier. Any physical damage to the unit after acceptance is not the responsibility of Greenheck Fan Corporation.

Unpacking

Verify that all required parts and the correct quantity of each item have been received. If any items are missing, report shortages to your local representative to arrange for obtaining missing parts. Sometimes it is not possible that all items for the unit be shipped together due to availability of transportation and truck space. Confirmation of shipment(s) must be limited to only items on the bill of lading.

Handling

Units are to be rigged and moved by the lifting brackets provided or by the skid when a forklift is used. Location of brackets varies by model and size. Handle in such a manner as to keep from scratching or chipping the coating. Damaged finish may reduce ability of unit to resist corrosion.

Storage

Units are protected against damage during shipment. If the unit cannot be installed and operated immediately, precautions need to be taken to prevent deterioration of the unit during storage. The user assumes responsibility of the unit and accessories while in storage. The manufacturer will not be responsible for damage during storage. These suggestions are provided solely as a convenience to the user.

OUTDOOR — Units designed for outdoor applications may be stored outdoors, if absolutely necessary. Roads or aisles for portable cranes and hauling equipment are needed.

The fan should be placed on a level surface to prevent water from leaking into the unit. The unit should be elevated on an adequate number of wooden blocks so that it is above water and snow levels and has enough blocking to prevent it from settling into soft ground. Locate parts far enough apart to permit air circulation, sunlight, and space for periodic inspection. To minimize water accumulation, place all unit parts on blocking supports so that rain water will run off.

Do not cover parts with plastic film or tarps as these cause condensation of moisture from the air passing through heating and cooling cycles.

Inspection and Maintenance during Storage

While in storage, inspect fans once per month. Keep a record of inspection and maintenance performed.

If moisture or dirt accumulations are found on parts, the source should be located and eliminated. At each inspection, rotate the fan wheel by hand ten to fifteen revolutions to distribute lubricant on motor. Every three months, the fan motor should be energized. If paint deterioration begins, consideration should be given to touch-up or repainting. Fans with special coatings may require special techniques for touch-up or repair.

Machined parts coated with rust preventive should be restored to good condition promptly if signs of rust occur. Immediately remove the original rust preventive coating with petroleum solvent and clean with lint-free cloths. Polish any remaining rust from surface with crocus cloth or fine emery paper and oil. Do not destroy the continuity of the surfaces. Wipe thoroughly clean with Tectyl® 506 (Ashland Inc.) or the equivalent. For hard to reach internal surfaces or for occasional use, consider using Tectyl® 511M Rust Preventive or WD-40® or the equivalent.

REMOVING FROM STORAGE — As units are removed from storage to be installed in their final location, they should be protected and maintained in a similar fashion, until the equipment goes into operation.

Prior to installing the unit and system components, inspect the unit assembly to make sure it is in working order.

1. Check all fasteners, set screws on the fan, wheel, bearings, drive, motor base, and accessories for tightness.
2. Rotate the fan wheel(s) by hand and assure no parts are rubbing.

Table of Contents

General Safety Information	1
Receiving, Handling and Storage	2
Product Overview	4
Subassembly Overview:	
Filter Section / Vertical Mounting Stand	4
Optional Service Platform	4
Burner, Blower and Control Center Overview	5
Burner Subassembly	6
Control Center	6
Dampers.	6
Installation	
Concrete Slab	7
Service and Access Clearance	7
Clearance to Combustibles	7
Burner/Blower Section.	7
Install Ductwork	7
Complete Installation	8
Optional Service Platform.	8-9
Electrical Wiring	10
Direct Gas Piping	11
Building Pressure Control, optional	12
Start-Up	
Checklist	13
Blower	14-15
Direct Gas	15-18
Operation	
Optional VAV Units.	19
Optional Recirculating Units	20
Electrical.	20-21
Troubleshooting	
Blower Does Not Operate	22
Motor Overamps	23
Insufficient Airflow	24
Too Much Airflow	24
Excessive Noise or Vibration	25
Heater Does Not Operate (Pilot Ignition).	26-28
Heater Does Not Operate (Direct Spark).	29-30
Maintenance	
Routine.	31
V-Belt Drives	31
Motors.	31
Wheels	31
Filters	31
Bearings	32
Fall	32
Start-Up	32
High Limit	32
Gas Train.	32
Reference	
Typical Gas Train Layout	33-34
Control Center Layout	35
Maintenance Log	Backcover
Warranty	Backcover

Product Overview

The model is a vertically-configured make-up air unit designed for outdoor installations. It contains a highly efficient direct-fired gas burner to provide a heat source for the building or to simply temper the air. The unit is designed to provide sufficient air to replace air that is exhausted from the building and will also produce heat as needed. The make-up air volume produced by the unit can be regulated in a number of different ways, depending on the characteristics of the building.

The unit draws in fresh, outdoor air through a filter bank in the bottom of the unit and it then moves upward through a combustion chamber or through an optional burner bypass damper. A blower mounted in the top of the unit then forces the air into the building ductwork.

Airflow Arrangement

The unit can be ordered in a number of different configurations to provide 100% outdoor air or 80% recirculated air and 20% outdoor air. These units can also be ordered with a variable air volume (VAV) capability for flexibility in response to building air handling needs.

100% Outdoor Air

If the unit is configured only for 100% outdoor air, it draws outdoor air as needed through the filter bank at the bottom. The air moves upward through the combustion chamber and then it is blown into the building through user-supplied ductwork. The supply air volume is typically constant and can only be altered by changing the blower or motor pulleys.

80/20 Recirculated Air

When the unit is used as a primary heat source for the building, the unit will draw 80% of the needed air from the building and mix it with a minimum of 20% fresh outdoor air. Outdoor air is drawn through the combustion chamber and then mixed with the indoor air after the direct-fired gas heater has heated the air. The supply air volume is typically constant but the percentage of recirculated air can be modulated.

Variable Air Volume (VAV)

The VAV function can be selected when the outdoor air volume required by the building varies. This requires the installation of one bypass damper and selection of an appropriate motor/blower control system. This may involve installation of a Variable Frequency Drive (VFD) controller. Both bypass damper and VFD are factory installed.

Subassemblies

Filter Section / Vertical Mounting Stand

The filter section of the unit is factory installed in the mounting stand and shipped ready for installation on the concrete mounting pad. Each filter unit has a large access panel on the control end of the unit except for the housing size 50, which has an access door on both ends. Filters are either 2 in. thick pleated paper or 2 in. thick permanent metal type. Filters are changed by removing the access door(s) and sliding the filters in or out on their tracks.

The unit's vertical mounting stand is fabricated of heavy-gauge, painted angle iron and flat stock steel. The nominal 24 in. high stand will support the entire unit so that the bottom of the filter unit is held 24 in. above ground level. For housing size 50, a nominal 48 in. high stand is minimum. In locations where heavy snowfall is common, greater minimum clearance should be specified in order to minimize the possibility of clogging filters with snow or debris. The stand with filter bank is shipped to the jobsite as a separate assembly. The unit filter bank is permanently installed in the mounting stand prior to shipment.

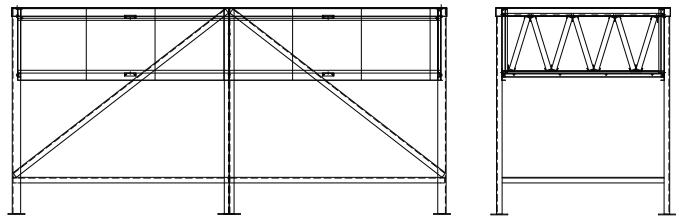

Optional Service Platform

A service platform is available for permanent attachment to the mounting stand. The platform is shipped unassembled and requires field assembly.

It is attached to the vertical mounting stand by installing bolts with spacers between the two assemblies. The service platform should be attached to the unit only after the burner and blower assemblies are permanently set in place.

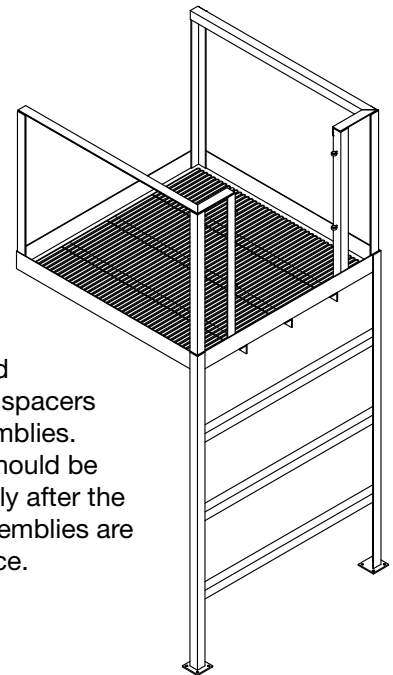

Burner, Blower and Control Center Section

The burner section, blower section and control center of the unit are all combined into one assembly which is installed in the field on top of the filter and stand section. The burner section is the lowest part of the burner / blower unit and it sits directly on the filter assembly. The burner section contains the gas train with its own access door and directly above that is the control center door. A number of different options are available for the gas train, which include type, size and location of burners and many different ignition and safety controls.

The blower section of the unit consists of one motor and either one or two forward curved blowers. It is the top-most assembly in the unit. If two blowers are used, their drive shafts are connected and driven by a single motor. Supply air discharge openings may be located either on the side wall of the unit for horizontal discharge, or may be configured for upblast discharge through the roof of the unit. One large access door is located directly above the control center, for inspection and maintenance of the motor and blower(s).

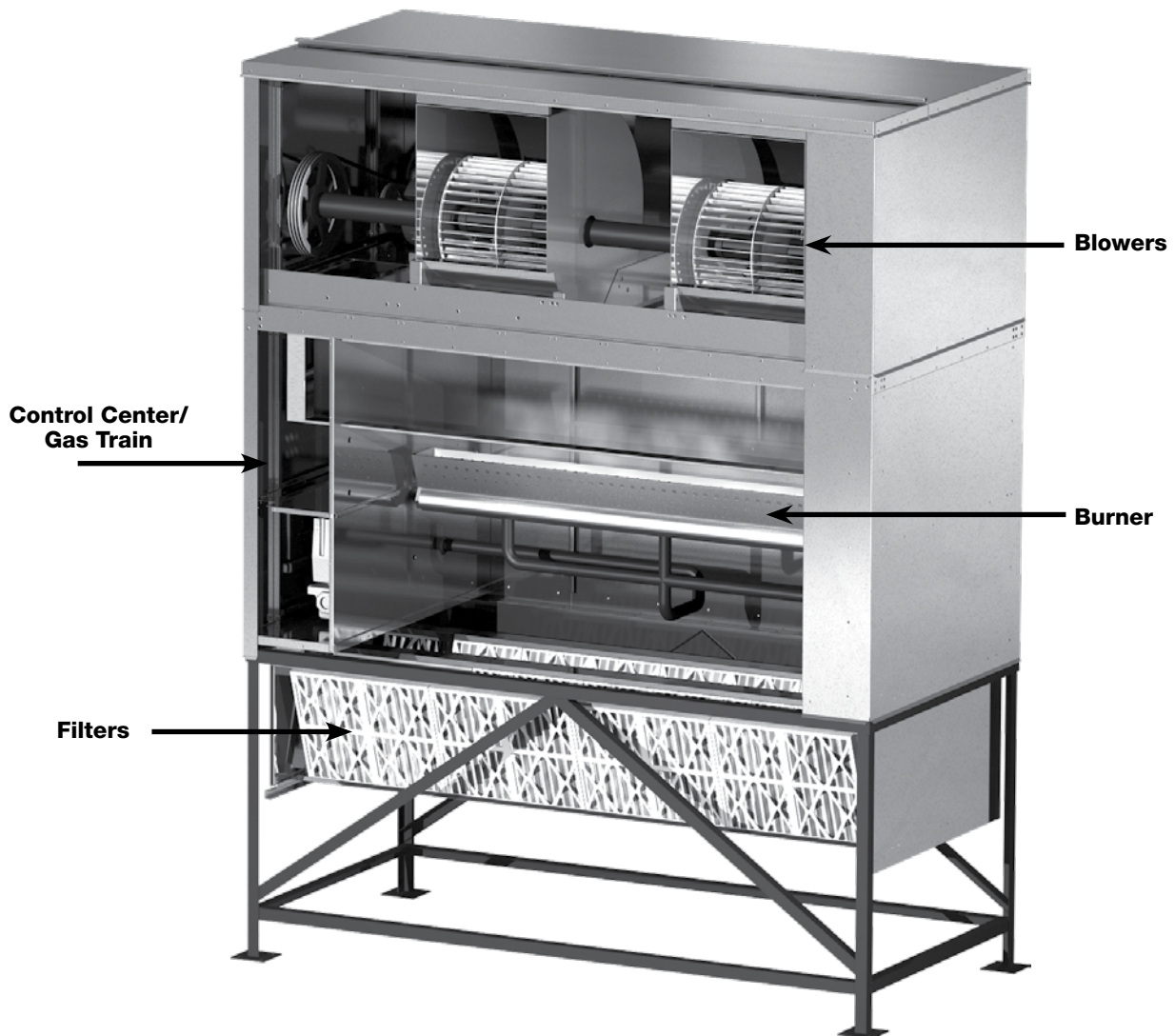

Open View

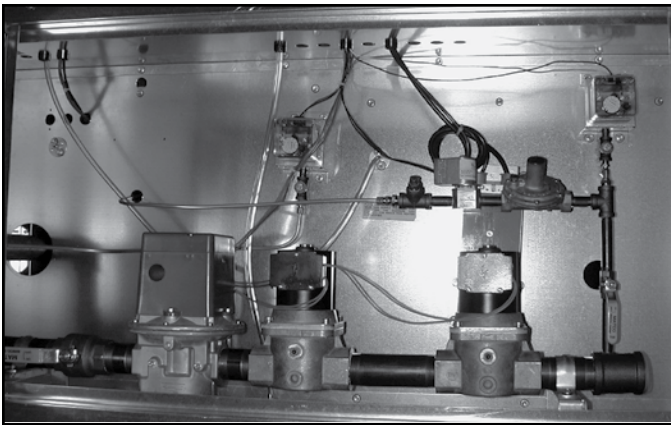

**Gas Train
(Burner Subassembly)**

Burner Subassembly

The burner subassembly consists of the gas train with its controls, valves, pressure regulator, burner(s), and combustion chamber. The primary gas connection to the gas train is made through the side wall grommet into the factory-supplied female pipe fitting.

Control Center

The control center is located on the end of the unit, directly above the gas train access door. The control center contains electronic components and some electromechanical devices that monitor and control the operation of the entire unit. A unit-specific wiring diagram is affixed to the inside of the access door.

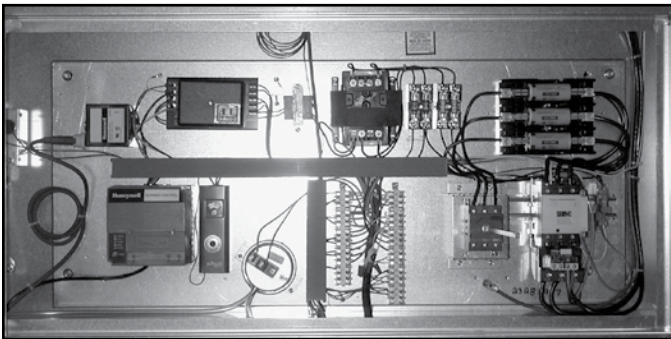

**Manual High Voltage
On/Off Switch
with Lockout**

High voltage supply wiring terminates at a manual on/off switch located on the face or the side of the unit, adjacent to the control center.

Low voltage control wiring from the building terminates on the terminal strips.

Dampers

There are four locations where optional dampers may be found. An optional motorized intake damper may be located horizontally on the bottom of the burner section. A patented passive control damper may be found adjacent to the burner opening plates if a VAV is ordered and a motorized damper may be installed vertically on the side of the burner section if recirculating air mode is chosen. In addition, an outlet damper may be shipped with the unit for field installation.

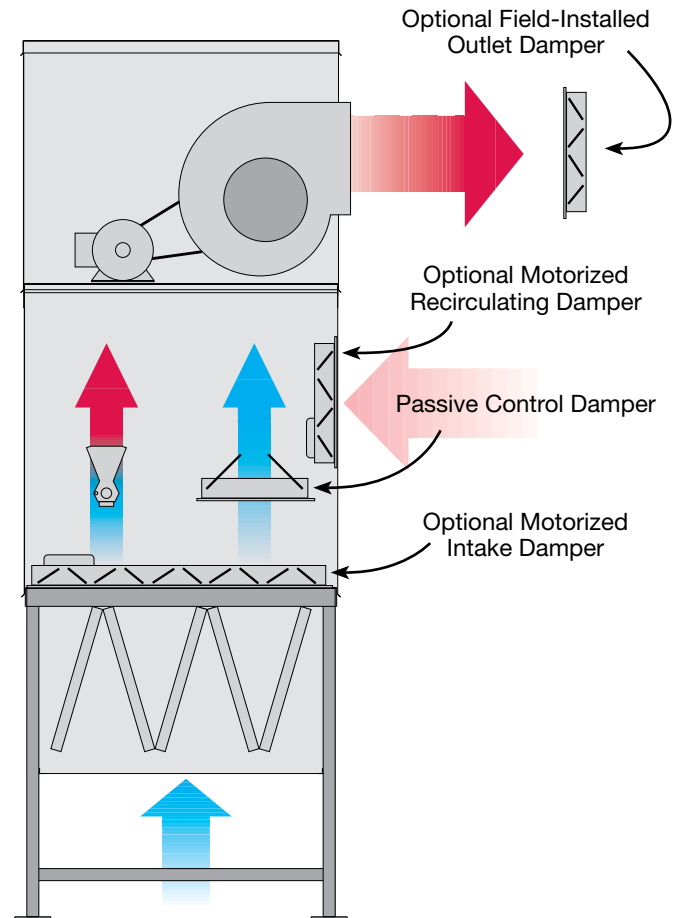

Installation

Concrete Slab

The first step in unit installation is to pour a concrete slab capable of holding the unit weight as a base. The slab should have a proper gravel drainage bed.

Concrete Slab Dimensions					
Housing Size	A	B	C	D	E
20	64	64	42	40	40
30	77	76	42	52	53
40	78	135	42	54	111
50	87	180	42	63	153

All dimensions are shown in inches.

NOTE

If optional service platform is included, a minimum of 42 inches must be added to Dimension B.

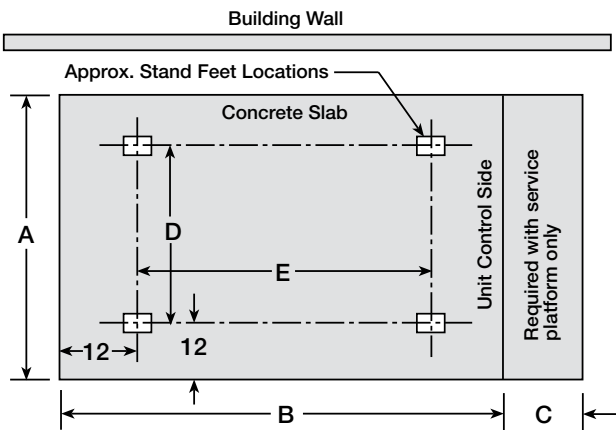

Concrete Slab and Unit Footprint

Service and Access Clearance

The slab should be positioned to allow 3 feet of clearance on the control end of the unit and 2 feet of clearance on the other three sides. Housing size 50 requires 3 feet of clearance on both ends because of filters access. Note that the concrete forms a 1 foot wide apron on all four sides of the unit unless a 42 in. extension is added to the control end of the unit.

Clearance to Combustibles

	Floor	Top	Sides	Ends
Insulated/ Units	0 in. (0 mm)	0 in. (0 mm)	0 in. (0 mm)	0 in. (0 mm)
Non Insulated Units	0 in. (0 mm)	6 in. (152.4 mm)	6 in. (152.4 mm)	6 in. (152.4 mm)

Clearance to combustibles is defined as the minimum distance required between the heater and adjacent combustible surfaces to ensure the adjacent surface's temperature does not exceed 90 degrees above the ambient temperature.

Burner/Blower Section

Use a crane and a spreader bar hooked to the factory lifting lugs (shown below) to lift and center the unit onto the filter stand section. The sections should be caulked together.

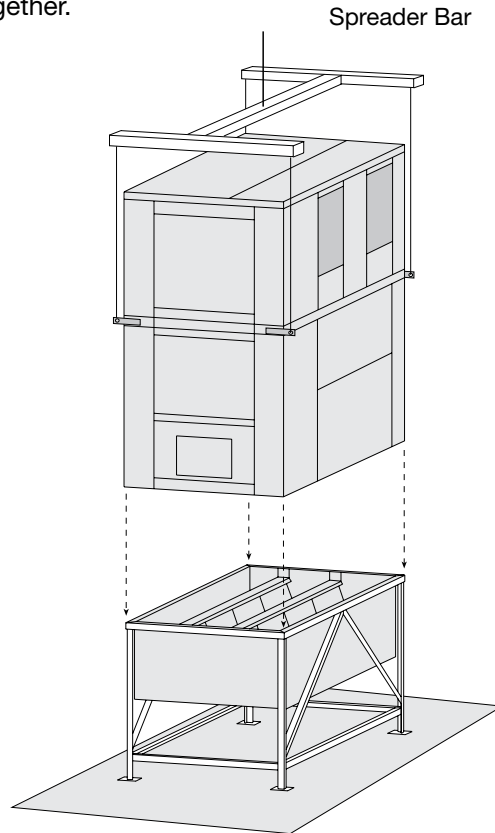

Install Ductwork

This table shows the duct sizes and straight lengths recommended for optimal performance (AMCA Publication 201-90). Using duct sizes less than recommended will affect fan performance. Good duct installation practices should be followed for the remaining ductwork.

Recommended Supply Ductwork Sizes		
VSU Blower Size	Duct Size (in.)	Straight Duct Length (in.)
108	10x13	32
109	14x13	38
110	16x14	42
112	18x16	48
115	19x16	49
118	24x22	64
120	28x28	79
218	68x24	114
220	68x26	118
225	104x37	175
230	104x37	203

Complete Installation

A typical horizontal discharge installation is shown. Gas and/or electrical lines can be connected at this time.

For upblast units, a duct elbow may be needed to turn the ductwork into the building. Follow proper ductwork methods recommended by AMCA to make this elbow to minimize duct losses.

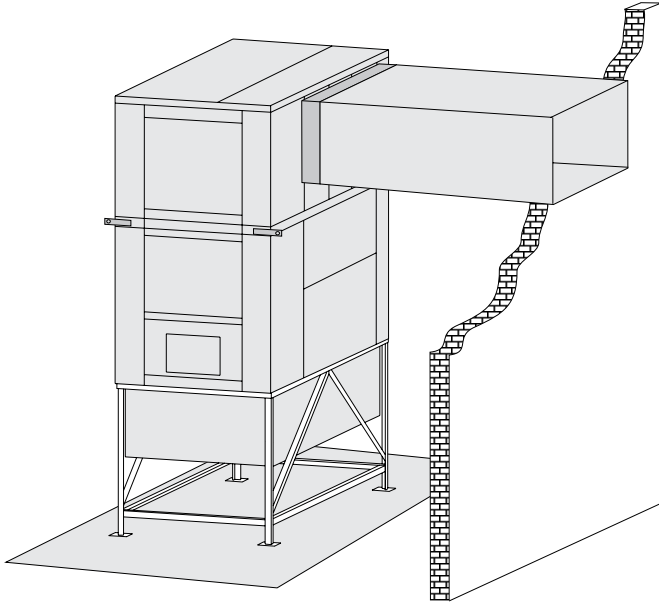

Installation of Optional Service Platform

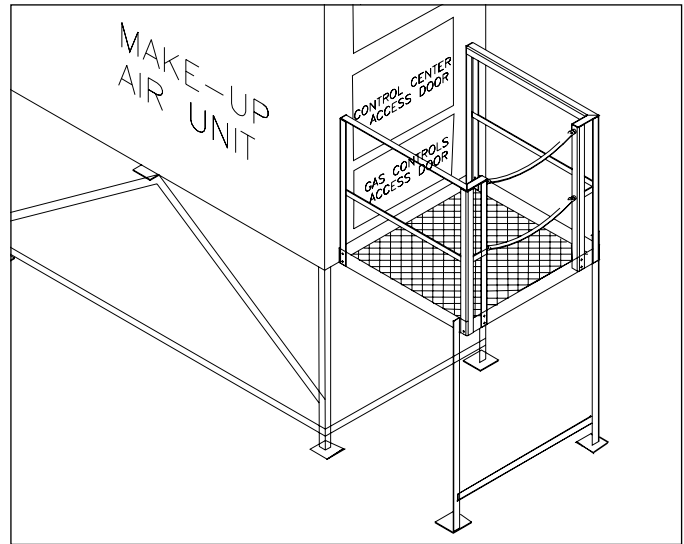

TOOLS REQUIRED

- (2) 9/16 in. sockets or wrenches
- Drill with 7/16 in. drill bit and 5/16 in. drill bit
- A crane or forklift is recommended for assembly and attachment.

Service Platform Material List

(1) Left Hand Rail with Safety Chains

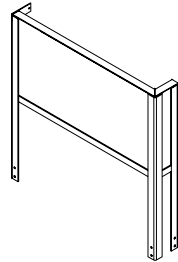

(1) Right Hand Rail

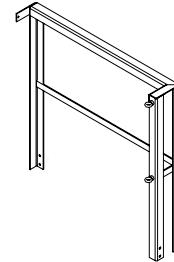

(2) Legs

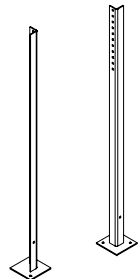

(1) Platform Base Unit with predrilled holes for hand rails, legs and attachments.

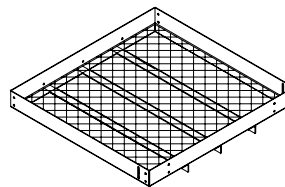

(1) Leg Cross Member

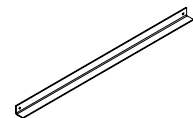

Fasteners

(3) Hex Head Bolts
3/8 in. x 1-1/2 in.



(2) Thread Cutting
Screws
3/8 in. x 1 in.

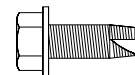

(18) Hex Head Bolts
3/8 in. x 3/4 in.

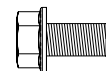

(27) Hex Head Nuts
3/8 in.



Assembly

1. Position platform base as shown below in Figure A with the grate side up.
2. Attach the left and right handrails to the platform base with (3/8 in. x 3/4 in.) hex head bolts and (3/8 in.) hex nuts as shown in Figure A. Use six bolts and nuts on each rail.
3. Raise the platform base, grate side up, with a crane or forklift.
4. Attach legs to the slots on sides of platform base with two (3/8 in. x 3/4 in.) hex head bolts and (3/8 in.) hex nuts.

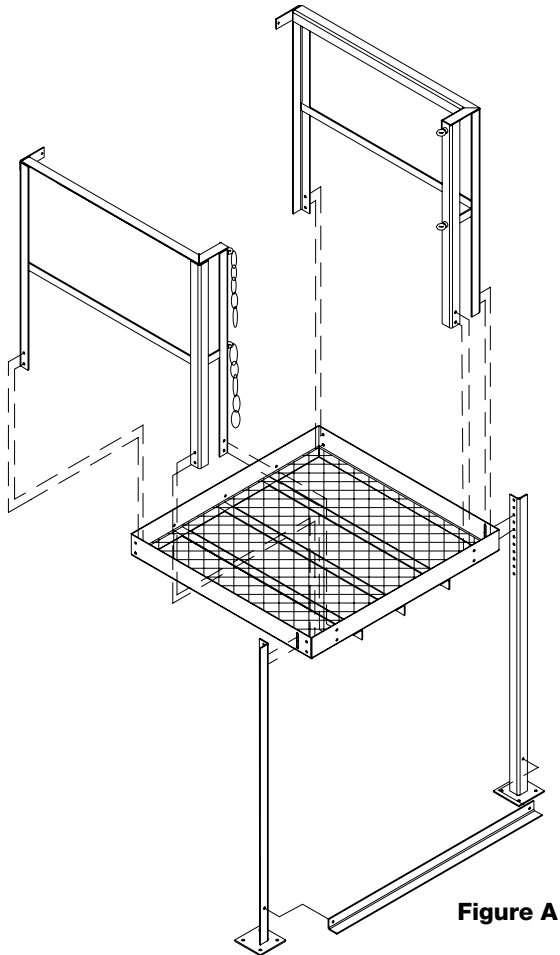

5. Fasten three (3/8 in. x 1-1/2 in.) hex head bolts into the side of the platform base. Secure each bolt with two (3/8 in.) hex head nuts placed back to back on each bolt as shown in Figure B. These bolts will be used to attach the platform base to the unit.

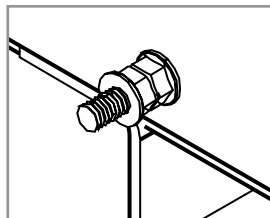

6. Facing the control panel side of the unit, find the center of the housing and drill a (7/16 in.) hole through the housing and support stand (3/8 in.) above the form line as shown in Figure C.

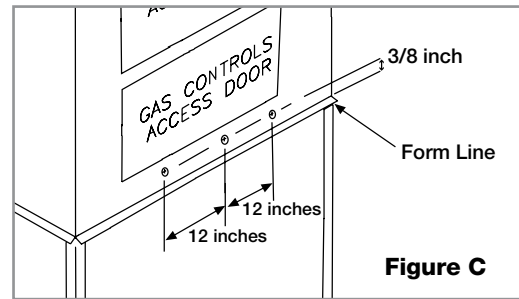

Next, drill two more (7/16 in.) holes through the housing and support stand (12 in.) on either side of the center hole, (3/8 in.) above the form line. These holes are used to attach the platform base to the unit.

7. Attach the service platform to the control panel side of the housing by inserting the three (3/8 in. x 1-1/2 in.) bolts of platform base into the three holes of the housing. Securely fasten with three (3/8 in.) hex nuts.
8. Level service platform if necessary by adjusting legs and then attach leg cross member with two (3/8 in. x 3/4 in.) hex head bolts and 3/8 in. hex head nuts.
9. Securely fasten all nuts and bolts. Make sure all nuts and bolts are tight.
10. Attach arm rails of service platform to the housing by first drilling a 5/16 in. hole through the housing at the attachment point as shown in Figure D. Secure arm rails to the housing with (3/8 in. x 1 in.) thread cutting screws. Be sure not to over-tighten screws.
11. Attach safety chains to the right hand rail, across the entryway. Assembly is complete.

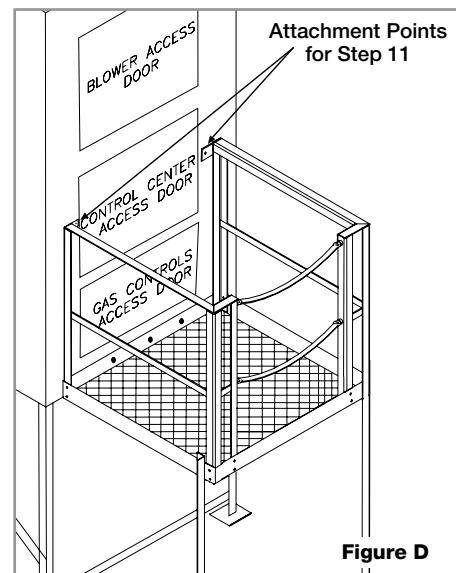

Installation of Electrical Wiring

IMPORTANT

Before connecting power to the unit, read and understand the following instructions and wiring diagrams. Complete wiring diagrams are attached on the inside of the control center door(s).

IMPORTANT

All wiring should be done in accordance with the latest edition of the National Electric Code ANSI/NFPA 70 and any local codes that may apply. In Canada, wiring should be done in accordance with the Canadian Electrical Code.

IMPORTANT

The equipment must be properly grounded. Any wiring running through the unit in the airstream must be protected by metal conduit, metal clad cable or raceways.

CAUTION

If replacement wire is required, it must have a temperature rating of at least 105°C, except for an energy cut-off or sensor lead wire which must be rated to 150°C.

DANGER

High voltage electrical input is needed for this equipment. This work should be performed by a qualified electrician.

CAUTION

Any wiring deviations may result in personal injury or property damage. Manufacturer is not responsible for any damage to, or failure of the unit caused by incorrect final wiring.

IMPORTANT

Manufacturer's standard control voltage is 24 VAC. Control wire resistance should not exceed 0.75 ohms (approximately 285 feet total length for 14 gauge wire; 455 feet total length for 12 gauge wire). If the resistance exceeds 0.75 ohms, an industrial-style plug-in relay should be wired in place of the remote switch. The relay must be rated for at least 5 amps and have a 24 VAC coil. Failure to comply with these guidelines may cause motor starters to chatter or not pull in, resulting in contactor failures and/or motor failures.

Determine the Size of the Main Power Lines

The unit's nameplate states the voltage and the unit's MCA. The main power lines to the unit should be sized accordingly. The nameplate is located on the outside of the unit on the control panel side.

Determine the Size of Electric Heater Wiring

An optional electric heater may require a separate power supply. The power connection should be made to the factory provided electric heater disconnect and

must be compatible with the ratings on the nameplate, supply power voltage, phase and amperage. Consult ANSI/NFPA 70 and CSA C22.1 for proper conductor sizing.

Connect the Main Power

Connect the main power lines to the disconnect switch and main grounding lug(s). Torque field connections to manufacturer's recommendations.

Wire the Optional Convenience Outlet

The convenience outlet requires a separate 115V power supply circuit. The circuit must include short circuit protection which may need to be supplied by others.

Wire the Optional Accessories

Reference the ladder diagram on the inside of the control center door for correct wiring of the following accessories:

- Selectra Stat
- Room Override
- Blower Switch
- Heat Switch
- Indicating Lights
- Dirty Filter Indicator
- TSCP
- KSCP

NOTE

Wiring to the Selectra Stat should be in separate conduit or run with shielded cable.

NOTE

TSCP has number-to-number wiring.

NOTE

Large evaporative coolers may require a separate power supply.

Connect Field-Wired Low Voltage Components

Most factory-supplied electrical components are prewired. To determine what electrical accessories require additional field-wiring, refer to the unit-specific wiring diagram located on the inside of the control center access door.

The low voltage control circuit is 24 VAC and control wiring should not exceed 0.75 ohms.

Control wires should not be run inside the same conduit as that carrying the supply power. Make sure that field-supplied conduit does not interfere with access panel operation. All low voltage wiring should be run in conduit wherever it may be exposed to the weather.

If wire resistance exceeds 0.75 ohms, an industrial-style, plug-in relay should be added to the unit control center and wired in place of the remote switch (typically between terminal blocks R and G on the terminal strip). The relay must be rated for at least 5 amps and have a 24 VAC coil. Failure to comply with these guidelines may cause motor starters to "chatter" or not pull in which can cause contactor failures and/or motor failures.

Installation of Direct Gas Piping

IMPORTANT

All gas piping must be installed in accordance with the latest edition of the National Fuel Gas Code ANSI/Z223.1 and any local codes that may apply. In Canada, the equipment shall be installed in accordance with the Installation Code for Gas Burning Appliances and Equipment (CGA B149) and Provincial Regulations for the class. Authorities having jurisdiction should be consulted before installations are made.

WARNING

All components of this or any other gas-fired heating unit must be leak tested prior to placing the unit into operation. A soap and water solution should be used to perform this test. NEVER test for gas leaks with an open flame.

WARNING

If pressure testing in excess of 1/2 psig (3.5 kPa), the heater and manual shutoff valve must be disconnected from the supply gas line.

WARNING

If pressure testing at or below 1/2 psig (3.5 kPa), the heater must be isolated from the supply gas line by closing its manual shutoff valve.

IMPORTANT

All piping should be clean and free of any foreign matter. Foreign material entering the gas train can damage the valves, regulators and burner.

IMPORTANT

Do NOT connect the unit to gas types other than what is specified and do NOT connect the unit to gas pressures that are outside of the pressure range shown on the label.

NOTE

When connecting the gas supply, the length of the run must be considered in determining the pipe size to avoid excessive pressure drop. Refer to a Gas Engineer's Handbook for gas pipe capacities.

Determine the Supply Gas Requirements

The unit's direct gas nameplate states the requirements for the gas being supplied to the unit. The direct gas nameplate is located on the outside of the unit on the control center side.

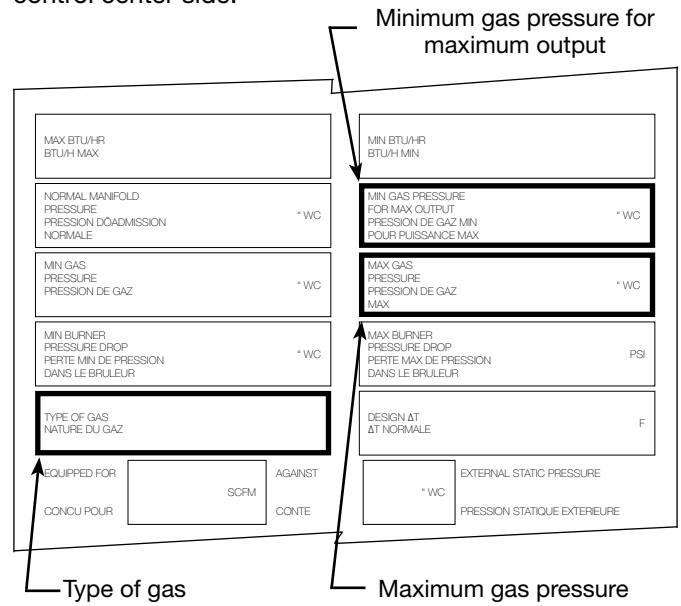

Direct Gas Nameplate

Install Additional Regulator if Required

When the supply gas pressure exceeds the maximum gas pressure shown on the direct gas nameplate, an additional regulator (by others) is required to reduce the pressure. The regulator must have a listed leak limiting device or it must be vented to the outdoors.

NOTE

The regulator located inside the unit is used to adjust the unit's maximum output temperature.

Connect the Supply Gas Line

A manual shut off valve (gas cock), 1/8 in. plugged test port and 6 in. drip leg must be installed prior to the gas train. The valve and the test port must be accessible for the connection of a test gauge. Supply gas connections must be made by a qualified installer and are not furnished by manufacturer.

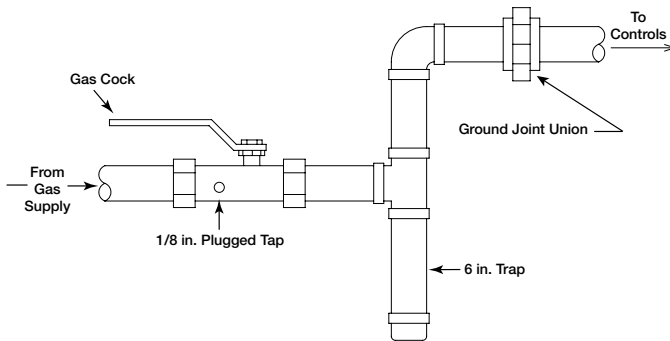

Supply Gas Line

WARNING

Reference the National Fuel Gas Code for additional vent line requirements.

Pipe the Optional Vent Line

If an optional vent line is located between the safety shutoff valves it must be piped to the outdoors.

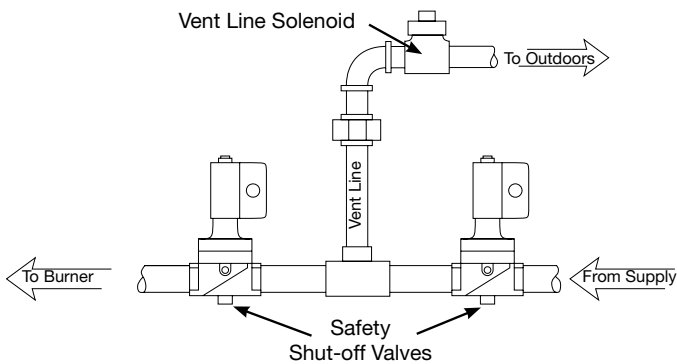

Optional Vent Line

Test the System for Leaks

Check both the supply lines and the factory piping for leaks. Apply a soap and water solution to all piping and watch for bubbling which indicates a leak.

WARNING

NEVER test for a gas leak with an open flame.

NOTE

The factory piping has been checked for leaks, but should be rechecked due to shipping and installation.

Installation of Building Pressure Control (optional)

Mount Pressure Tap

Using the factory provided bracket, mount the pressure tap to the outside of the unit. Choose a location out of the prevailing winds and away from supply or exhaust fans to assure accurate readings.



Run Pressure Tap Lines

Run a pressure tap line from the pressure tap on the outside of the unit to the low pressure tap on the back of the photohelic gauge. Run a second pressure tap line from the high pressure tap on the back of the photohelic gauge to the space. Fifty feet of tubing is supplied with the unit.

Set the Building Pressure

The pressure gauge is used to set the desired building pressure. The pressure is set by adjusting the knobs for the upper and lower pressure limits. Typical settings are 0.0 in. wg for the lower and 0.10 in. wg for the upper pressure setting.

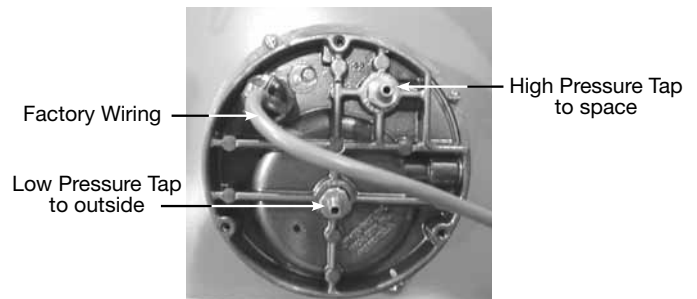

Connections for Photohelic Gauge

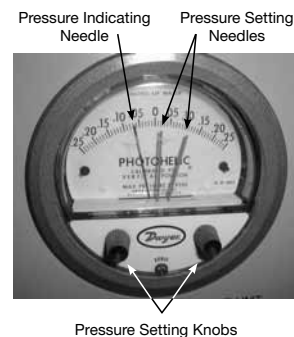

Typical Photohelic Gauge Settings

Start-Up - Checklist

Unit Model Number _____
 (e.g. VSU-H20)

Unit Serial Number _____
 (e.g. 10111000)

Start-Up Date _____

Start-Up Personnel Name _____

Start-Up Company _____

Phone Number _____

Pre Start-Up Checklist – check boxes as items are completed.

- Check tightness of all factory wiring connections
- Verify control wiring wire gauge
- Hand-rotate blower to verify free rotation
- Verify supply voltage to the main disconnect
- Verify the supply gas pressure
- Verify remote controls wiring
- Check V-belt drive for proper alignment and tension

Start-Up Blower Checklist – refer to Start-Up - Blower section for further detail.

- Check line voltage L1-L2 _____
 L2-L3 _____
 L1-L3 _____
- Check blower rotation
- Check for vibration
- Supply fan RPM _____ RPM
- Motor nameplate amps _____ Amps
- Actual motor amps _____ Amps
- Actual CFM delivered _____ CFM

Optional Accessories – refer to Start-Up - Blower, Set-Up Optional Components, pg. 15 for further detail.

- Heating Inlet Air Sensor
 _____ Actual Setting
Typical setting 60°-70°F
- Cooling Inlet Air Sensor
 _____ Actual Setting
Typical setting 75°F
- Building Freeze Protection
 _____ Actual Setting
Typical setting 5 minutes; 45°F
- Dirty Filter Gauge
 _____ Actual Setting
Typical setting varies

Start-Up Direct Gas (Pilot Ignition) – refer to Start-Up - Direct Gas section for further detail.

- Check supply gas pressure
 _____ Maximum
 _____ Minimum
 _____ Actual
- Check Pilot Gas Pressure
 _____ Actual Setting
Typical 3.0 in. wg
- Set optional High Gas Pressure Switch
 _____ Actual Setting
Typical 8.0 in. wg
- Set optional Low Gas Pressure Switch
 _____ Actual Setting
Typical 3.0 in. wg
- Set Burner Pressure Differential
 _____ Actual Setting
Typical 0.65 in. wg
- Set the maximum firing rate
 _____ temp rise
- Set the minimum firing rate
 _____ check
- Set the unit's operating temperature
 _____ °F

Start-Up Direct Gas (Direct Spark) – refer to Start-Up - Direct Gas section for further detail.

- Check supply gas pressure
 _____ Maximum
 _____ Minimum
 _____ Actual
- Set optional High Gas Pressure Switch
 _____ Actual Setting
Typical 8.0 in. wg.
- Set optional Low Gas Pressure Switch
 _____ Actual Setting
Typical 3.0 in. wg.
- Set Burner Pressure Differential
 _____ Actual Setting
Typical 0.65 in. wg
- Set the maximum firing rate
 _____ temp rise
- Set the minimum firing rate
 _____ check
- Set the unit's operating temperature
 _____ °F

Start-Up - Blower

WARNING

Check the housing, blower, and ductwork for any foreign objects before running the blower.

WARNING

Disconnect and lock-out all power and gas before performing any maintenance or service to the unit. Failure to do so could result in serious injury or death and damage to equipment.

SPECIAL TOOLS REQUIRED

- Voltage Meter (with wire probes)
- Amperage Meter
- Pressure Gauges – (refrigerant)
- Tachometer
- Thermometer
- Incline manometer or equivalent

Check the Voltage

Before starting the unit, compare the supplied voltage, hertz, and phase with the unit and motor's nameplate information.

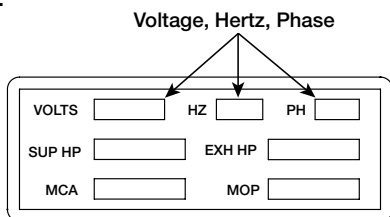

Electrical Nameplate

Check the Blower Rotation

Open the blower access door and run the blower momentarily to determine the rotation. Arrows are placed on the blower scroll to indicate the proper direction or reference the example shown to the right.

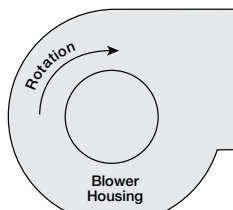

Blower Rotation

NOTE

To reverse the rotation on three phase units, disconnect and lock-out the power, then interchange any two power leads.

NOTE

To reverse the rotation on single phase units, disconnect and lock-out the power, then rewire the motor per the manufacturer's instructions.

IMPORTANT

If the blower is rotating in the wrong direction, the unit will move some air, but will not perform as designed. Be sure to perform a visual inspection to guarantee the correct blower rotation.

Check for Vibration

Check for unusual noise, vibration or overheating of the bearings. Reference the Troubleshooting section for corrective actions.

IMPORTANT

Excessive vibration may be experienced during the initial start-up. Left unchecked, it can cause a multitude of problems including structural and/or component failure.

IMPORTANT

Generally, fan vibration and noise is transmitted to other parts of the building by the ductwork. To minimize this undesirable effect, the use of heavy canvas duct connectors is recommended.

Motor Check

Measure the motor's voltage, amps and RPM. Compare to the specifications. Motor amps can be reduced by lowering the motor RPM or increasing system static pressure.

IMPORTANT

Additional starters and overloads may be provided in the make-up air control center for optional exhaust blowers. Any additional overloads must be checked for proper voltage, amps and RPMs.

Air Volume Measurement and Check

Measure the unit's air volume (cfm) and compare it with the rated air volume. If the measured air volume is off, adjust the fan's RPM by changing/adjusting the drive.

NOTE

The most accurate way to measure the air volume is by using a pitot traverse method downstream of the blower. Other methods can be used, but should be proven and accurate.

IMPORTANT

Changing the air volume can significantly increase the motor's amps. If the air volume is changed, the motor's amps must be checked to prevent overloading the motor.

NOTE

To ensure accuracy, the dampers are to be open when measuring the air volume.

Set-Up Optional Components

Adjust the settings on the optional components. See the unit's specific wiring diagram located on the access door or the unit.

- Heating Inlet Air Sensor
Typical setting: 60-70°F
- Building Freeze Protection
Typical setting: 5 minutes; 45°F
- Dirty Filter Gauge
Typical setting: Settings vary greatly for each unit.
(see Reference section for adjusting information)

Start-Up - Direct Gas

IMPORTANT

For proper unit function and safety, follow the start-up procedure in the exact order that it is presented.

IMPORTANT

This start-up should begin after all of the installation procedures and the blower start-up have been completed.

Check the Supply Gas Pressure

Check the supply gas pressure and compare it with the unit's nameplate pressure requirements. Adjust the supply regulator as needed until the supply gas pressure is within the specified range. The direct gas nameplate is located on the outside of the unit on the control center side.

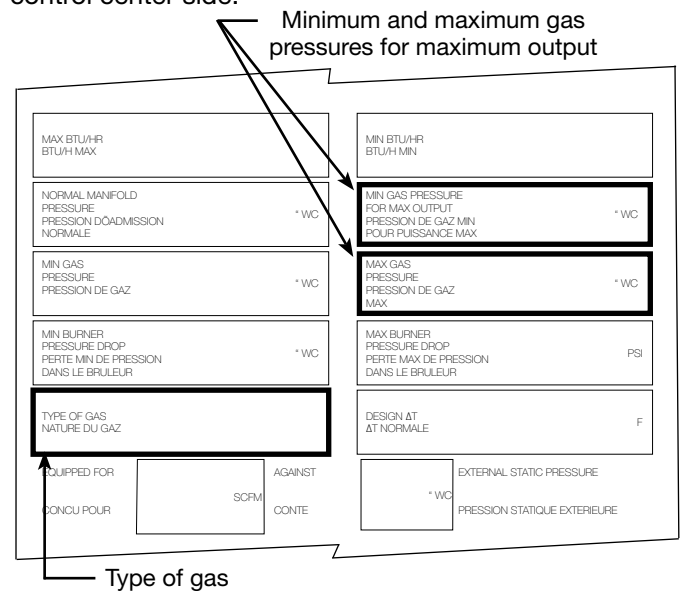

Direct Gas Nameplate

Check the Pilot Gas Pressure

Check the pilot gas pressure. The recommended gas pressure is 3 in. wg. Adjust the pilot regulator as needed. See the Gas Train Layout in the Reference section for the location of the pilot pressure test port and pilot regulator.

Check the Optional High and Low Gas Pressure Switches

Check the settings on the high and low gas pressure switches. The high gas setting is typically 8 in. wg (2 kPa) and the low gas setting is typically 3 in. wg (0.7 kPa). The switches are set at the factory and should not need adjustment. Adjust the settings if needed. See the Gas Train Layout in the Reference section for the high and low pressure switch location.

IMPORTANT

The purpose of the high and low gas pressure switches is to automatically shut down the burner if the inlet gas pressure is too low for the burner to safely light, or if the manifold pressure is too high for the burner to operate properly.

Set the Burner Air Pressure Differential

With the fan running and discharging 70°F (21°C) air, connect a U-Tube manometer to the outer sensing probes (see below) and measure the static pressure across the burner.

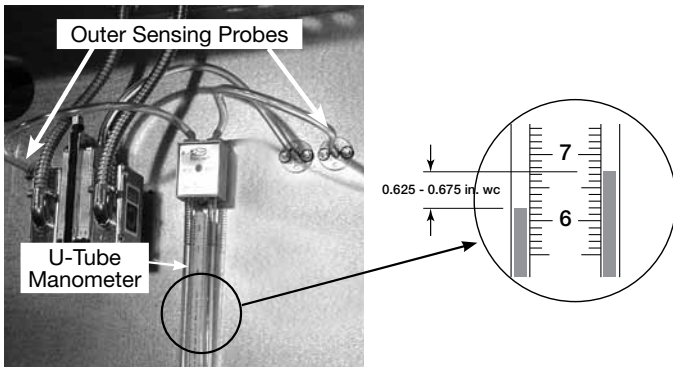

Measuring the Pressure Drop

IMPORTANT

Proper air velocity over the burner is critical on direct-fired gas units. If the air velocity is not within the unit specifications, the unit will not operate efficiently, may have sporadic shutdowns, and may produce excessive carbon monoxide (CO) or other gases.

The proper static pressure should be between 0.625 and 0.675 in. wg (155.68 and 168.64 Pa). If needed, evenly adjust the baffles on both sides of the burner, keeping the burner centered in the opening until the required pressure is obtained.

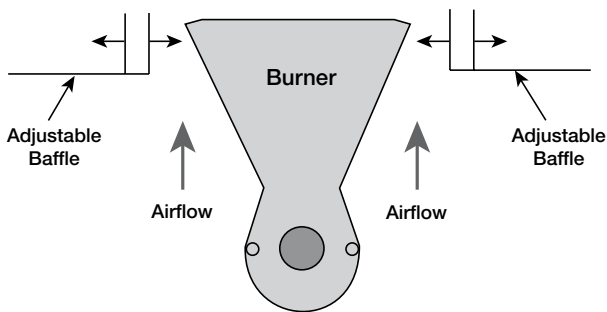

Burner and Baffles

NOTE

The pressure drop was set at the factory and may not need adjustment.

NOTE

When required pressure is obtained, be sure to reconnect the outer sensing probes.

IMPORTANT

This process may need to be repeated until the proper pressure is achieved. This adjustment will change the air quantity delivered by the unit and therefore the air quantity delivered should be rechecked. Refer to the Blower Start-Up section.

NOTE

To increase the static pressure decrease the opening. To decrease the static pressure increase the opening.

Set the Maximum Firing Rate

Monitor the unit's actual temperature rise by placing a thermocouple in the unit's inlet and a second in the discharge, three duct diameters downstream of the burner. Send the unit to maximum fire by disconnecting and isolating the wire connected to Terminal 3 on the Maxitrol 14 or the Maxitrol 44. See images on page 18.

While monitoring the units temperature rise, set the maximum firing rate by adjusting the regulator until the designed temperature rise is achieved. After setting the maximum firing rate, reconnect the wire to the amplifier.

NOTE

Do not set the burner maximum firing rate based on gas pressure. It should be set based on the unit's designed temperature rise shown on the direct gas label.

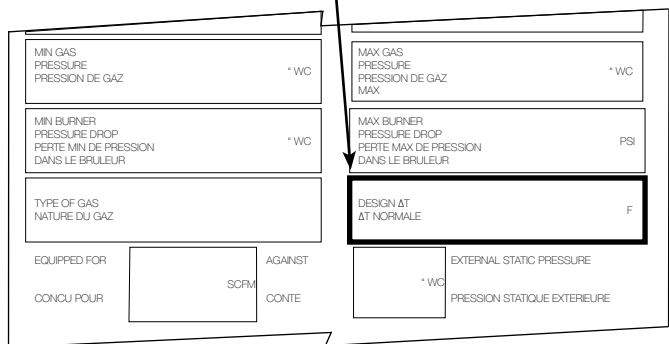

Direct Gas Nameplate



Maximum firing rate adjustment

Combined Regulator Valve

IMPORTANT

Setting the maximum firing rate during mild weather conditions may cause the high limit to trip out during extreme conditions requiring manual resetting.

NOTE

Gas trains are equipped with either separate regulators and modulating valves or with a combined modulating valve.

NOTE

Clockwise rotation increases the temperature rise, counterclockwise rotation decreases the temperature rise.

NOTE

The minimum setting for the maximum firing rate may be higher than required. This is acceptable. The burner will modulate as needed.

Set the Minimum Firing Rate

Disconnect and isolate one of the wires running to the modulating valve to send the unit to its minimum firing rate. Set the minimum firing rate by adjusting the needle valve indicated.

After setting the minimum firing rate, shut off the pilot to ensure that the flame safeguard can still read the main flame signal. Reconnect the wire to the modulation valve and open the pilot shut-off valve.

IMPORTANT

The proper minimum firing rate setting results in a small ribbon of continuous flame which covers the flame rod and runs across the entire burner.

IMPORTANT

Do not allow the disconnected wire to come in contact with a potential ground. Damage to the amplifier or transformer could result.

IMPORTANT

On units with a 42 inch or greater burner, the flame safeguard will automatically shut off the pilot after the burner has been ignited.

NOTE

Gas trains are equipped with either separate regulators and modulating valves or with a combined modulating regulator.

NOTE

Adjusting the maximum and minimum firing rate requires the inlet air sensor to be set higher than the outdoor air temperature in order to start the burner(s). Once high and low fire have been set, the inlet air sensor should be set to the desired temperature.

NOTE

Counterclockwise rotation increases the minimum fire rate setting, clockwise rotation decreases the setting.

Regulators and Modulating Valves

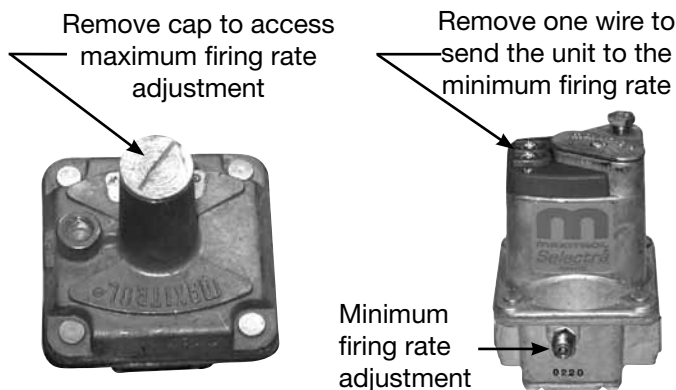

Separate Regulator and Modulating Valves

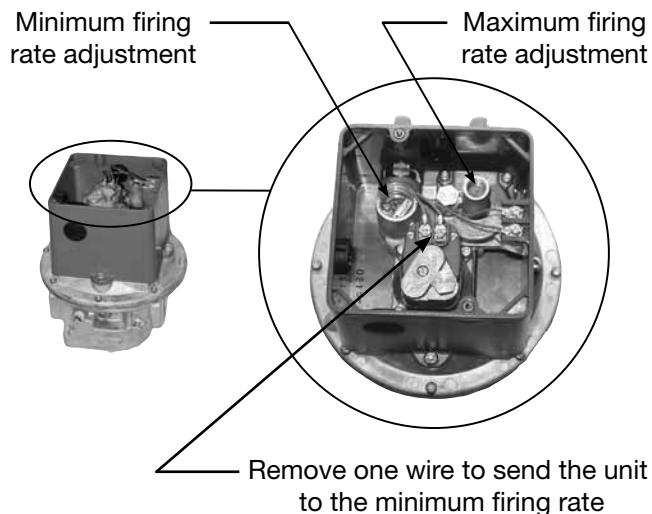

Combined Modulating Regulator

Set the Unit's Operating Temperature

Set the operating temperature. **The operating temperature setting depends on which Maxitrol controller is used.**

Maxitrol Series 14 – 8 Terminals: The Maxitrol Series 14 should be set to the desired discharge temperature mode. Place dipswitch in the “UP” position for local control and in the “DOWN” position for remote control. Keep LFST dipswitch in the “UP” position at all times for 10 second delay.

Fig. A is required for remote control.

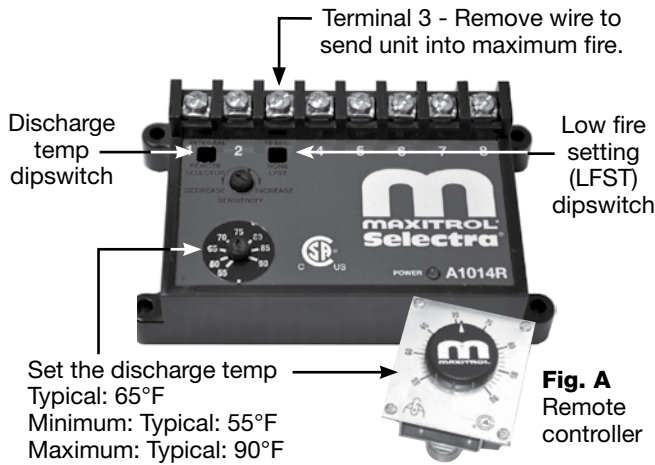

Maxitrol Series 14 – 8 terminals

Maxitrol Series 44 – 9 Terminals: The Maxitrol Series 44 should be set to the desired discharge temperature. The temperature selector is a stand-alone dial. The stand-alone dial may be mounted remotely.

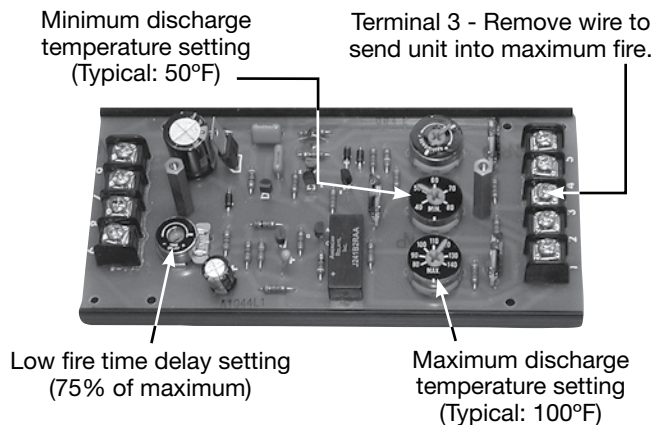
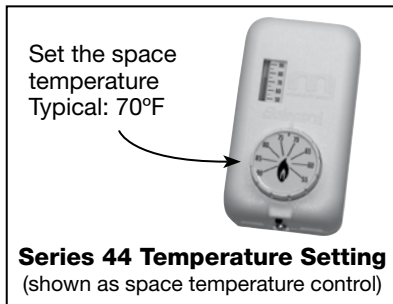

Maxitrol Series 44 – 9 terminals

Maxitrol SC25S: The SC25S is an analog signal converter that will change a 0-10 VDC or a 4-20 mA control signal provided by an owner supplied Building Management System into an output level capable of driving one or more modulating gas valves. The SC25S also limits the minimum and maximum discharge air temperatures. Reference the unit-specific wiring diagram and Maxitrol data sheets included in the IOM packet.



Maxitrol SC25S

Flame Signal Check - Pilot Ignition

To measure the flame signal connect a standard DC voltmeter to the flame amplifier test jacks + and - (com) as shown to the right. The flame signal should be above 1.25 VDC and steady.



DC Voltmeter and Flame Amplifier

Check the flame signal with the burner at pilot only, minimum fire, mid fire and high fire.

IMPORTANT

If the flame signal is not above 1.25 VDC and steady, consult the troubleshooting section.

Operation - VAV Units (optional)

NOTE

Blower Start-Up, as shown on page 14, should be performed before the blower is run.

NOTE

For maintenance issues associated with variable frequency drives, consult the drive's manual supplied with the unit. The drives are programmed at the factory and should not need any adjustment during installation and start-up. For kitchen applications, the drive may be located in the kitchen or in the unit.

Variable Volume Operation

The variable volume option is recommended when a building's exhaust volume may vary. This option enables the make-up air volume to track with the exhaust volume, providing only the amount of make-up air required. Control strategies include 2-speed and modulating blowers. Before the unit is left in service, the variable volume control system should be tested.

2-Speed

A variable frequency drive (VFD) is used to control air volumes. The VFD can be switched to low or high speed from a remote control panel. Turn the fan speed switch on the remote control panel to each position and confirm that the fan speed adjusts accordingly.

Modulating

Potentiometer Control — a variable frequency drive is controlled by input from a remote speed selector (potentiometer). This unit allows easy manual adjustment of make-up air volumes. To test potentiometer operation, turn the potentiometer to the two extremes. With variable volume, make sure the fan goes to maximum and minimum speed.

When the potentiometer is at 0, the fan speed will be at its minimum. When the potentiometer is at 100, the fan will be at its maximum speed.

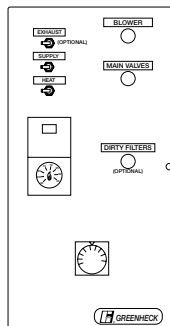

Potentiometer Control

Building Pressure Control —

a variable frequency drive is controlled according to input from a pressure sensing device.

Turn both knobs to the upper most pressure setting. You may have to remove the outdoor pressure tap tubing. VAV systems should go to maximum speed. Set both knobs at the lowest setting and the VAV systems should go to minimum speed.

Reset the correct pressure limits before starting the unit.

This picture depicts a typical photohelic setting. Typical settings are 0.0 in. wg for the lower pressure setting and 0.10 in. wg for the upper pressure setting. The needle indicates a negative building pressure. During correct operation, the indicating needle will remain between or near the setting needles.

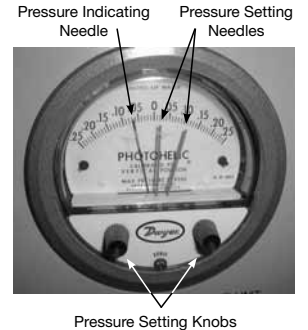

Photohelic Gauge

External Signal — a variable frequency drive is controlled according to input from an external 2-10 VDC or 4-20 mA signal (by others).

A 2 VDC or 4 mA signal will send the blower to low speed. The blower will go to maximum speed with a 10 VDC or 20 mA signal.

Variable Kitchen Control — A variable frequency drive is controlled by input from a remote speed control. This unit allows automatic adjustment of make-up air volumes based on varying cooking loads.

Burner Bypass Damper (optional)

The self-adjusting burner bypass damper is a device used in variable volume units. Its function is to maintain proper combustion by providing a constant airflow over the burner when outside air volumes are changed. It is located underneath the burner as shown in the picture.

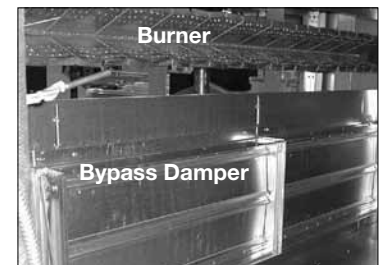

Burner Bypass Damper

WARNING

The burner bypass damper is set-up at the factory. The weights should not be adjusted in the field. The damper may not fully close during minimum outside air mode.

Operation - Recirculating Units (optional)

NOTE

Blower Start-Up, as shown on page 14, should be performed before the blower is run.

Recirculation Operation

The recirculation operation option is recommended when the ventilation equipment provides the primary source of heating for the space. A minimum of 20% outdoor air is mixed with up to 80% filtered recirculated air. Control strategies include 2-position and modulating dampers.

Before the unit is left in service, the recirculation control system should be tested.

2-Position Damper

A 2-position spring return actuator is used to control the return air amounts. The damper moves from open to closed. If power is cut to the unit, the outdoor air damper will fail to close.

Turn the recirculating switch on the remote control panel to each position and confirm that the return air damper adjusts accordingly. The damper actuator may take a few minutes to open or close.

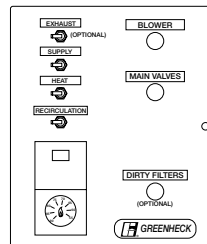

2-Position Damper Control

Modulating

Potentiometer Control — a modulating spring return actuator is used to control the return air amounts.

The return air damper modulates from fully open to fully closed based on a signal from a remote potentiometer.

To test potentiometer operation, turn the potentiometer to the two extremes. With 80/20 recirculation, confirm that the return air damper fully opens and fully closes. When the potentiometer is at 0, the return air damper will open. When the potentiometer is at 100, the return air damper will close. The damper actuator may take a few minutes to open or close.

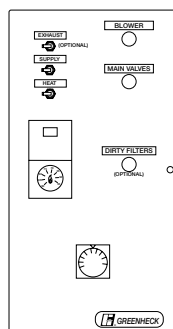

Potentiometer Control

Building Pressure Control — a modulating spring return actuator is used to control the return air amounts. The return air damper modulates from fully open to fully closed based on a signal from a remote pressure sensing device.

Turn both knobs to the upper most pressure setting. You may have to remove the outdoor pressure tap tubing. The return air damper should close.

Set both knobs at the lowest setting and the damper should open. It may take one to two minutes for the damper to reach the desired position.

Reset the correct pressure limits before starting the unit.

This picture shows a typical photohelic setting. Typical settings are 0.0 in. wg for the lower and 0.10 in. wg for the upper pressure setting. The needle in this photo indicates a negative building pressure. During correct operation, the indicating needle will remain between or near the setting needles.

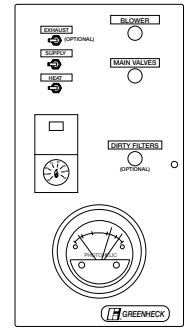

Building Pressure Control

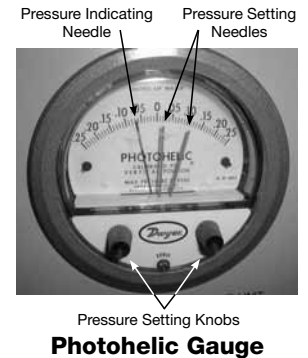

External Signal — a modulating spring return actuator is used to control the return air amounts. Return air damper modulates from fully open to fully closed based on an external 2-10 VDC or 4-20 mA signal (by others).

The return air damper will close with a 10 VDC or 20 mA signal. The return air damper should open with a 2 VDC or 4mA signal. The damper actuator may take a few minutes to open or close.

Operation - Electrical

Electrical Sequence

1. Exhaust Fan Contact (S1) Closed (optional)

- Power passes to N.C. exhaust overload contact (ST2 OL) (optional)
- Power passes to exhaust starter(s) ST2
- N.O. exhaust starter switches are energized and closed
- Power passes to exhaust fans
- Exhaust fan(s) (M2) start

2. Supply Fan Contact (S2) Closed

- Power passes through N.C. field supplied fire contact (FSC)
- Power passes through N.O. exhaust fan contact (ST2), which is closed when the exhaust relay (ST2) is activated (optional)

- Power passes to N.C. supply overload contact (ST1 OL)
- Power passes through N.C. contact on optional freeze protection timer (RT4) which remains closed if the temperature has remained above the set point
- Power passes to optional inlet damper which opens
- When damper is fully opened, damper relay (D1) is energized and optional N.O. damper limit switch (DL1) closes
- Power passes to and energizes supply starter relay (RF)
- Power passes to N.O. fan contact (RF), which is energized and closed
- Supply starter (ST1) is energized
- Supply starter contact (ST1) closes and power reaches and energizes supply fan
- Supply fan (M1) starts
- Power passes to optional N.O. and N.C. high and low gas pressure contacts (PS4 and PS3), which are both closed if gas pressure is within the set range
- Power passes to N.O. and N.C. airflow switches (PS2) which are closed if there is proper airflow across the burner
- Power passes to terminal TH on the Flame Safeguard (FSG) which begins its sequence (see Direct Gas Burner Sequence)

3a. Heat Contact (S4) Closed - Pilot Ignition

- Power passes to N.O. fan relay (RF) which is energized and closed
- Power passes to optional inlet air sensor contact (TS4) which is energized and closed if the inlet air temperature is below the set point
- Power passes to and energizes the heat relay (RH)
- N.O. heat relay contact (RH) closes
- Power passes to and energizes terminal 5 of the Flame Safeguard (FSG). Power light on FSG is on.
- Power passes to N.C. high limit control contact (HLC1) which is closed if temperature has remained below set point
- Power passes to optional N.O. and N.C. high and low gas pressure contacts (PS4 and PS3), which are both closed if gas pressure is within the set range
- Power passes to terminal 6 of the Flame Safeguard (FSG)
- Power begins direct gas burner sequence (see Direct Gas Burner Sequence)

3b. Heat Contact (S4) Closed - Direct Spark

- Power passes to N.O. fan relay (RF) which is energized and closed
- Power passes to optional inlet air sensor contact (TS4) which is energized and closed if the inlet air temperature is below the set point
- Power passes to and energizes the heat relay (RH)
- N.O. heat relay contact (RH) closes
- Power passes to N.C. high limit control contact (HLC1) which is closed if temperature has remained below set point

Direct Gas Burner Sequence - Pilot Ignition

1. Supply Fan Contact Closed

- Power passes to the supply fan and heat switch

2. Heat Contact Closed

- Power passes to the heat relay then to the Flame Safeguard

3. Flame Safeguard (FSG) Sequence

- Checks for proper airflow
- Verifies no flame present at burner
- Initiates 10 second prepurge
- Sends power to open pilot gas valve (V1) and energizes the spark generator (SG) (clicking of the spark generator may be heard)
- Tries for up to 10 seconds to light pilot and confirm flame
- Powers the main gas valves open
- Shuts down spark generator
- Continuously monitors the flame and airflow
- Performs self-diagnostic check every five seconds.

Direct Gas Burner Sequence - Direct Spark

1. Supply Fan Contact Closed

- Power passes to the supply fan and heat switch

2. Heat Contact Closed

- Power passes to the heat relay then to the Flame Safeguard

3. Flame Safeguard (FSG) Sequence

- Checks for proper airflow
- Verifies no flame present at burner
- Initiates 15 second prepurge
- Sends power to open gas valve (V2) and energizes the spark generator (clicking of the spark generator may be heard)
- Tries for up to 10 seconds to light and confirm flame
- Shuts down spark generator
- Continuously monitors the flame and airflow

Troubleshooting

Blower Does Not Operate

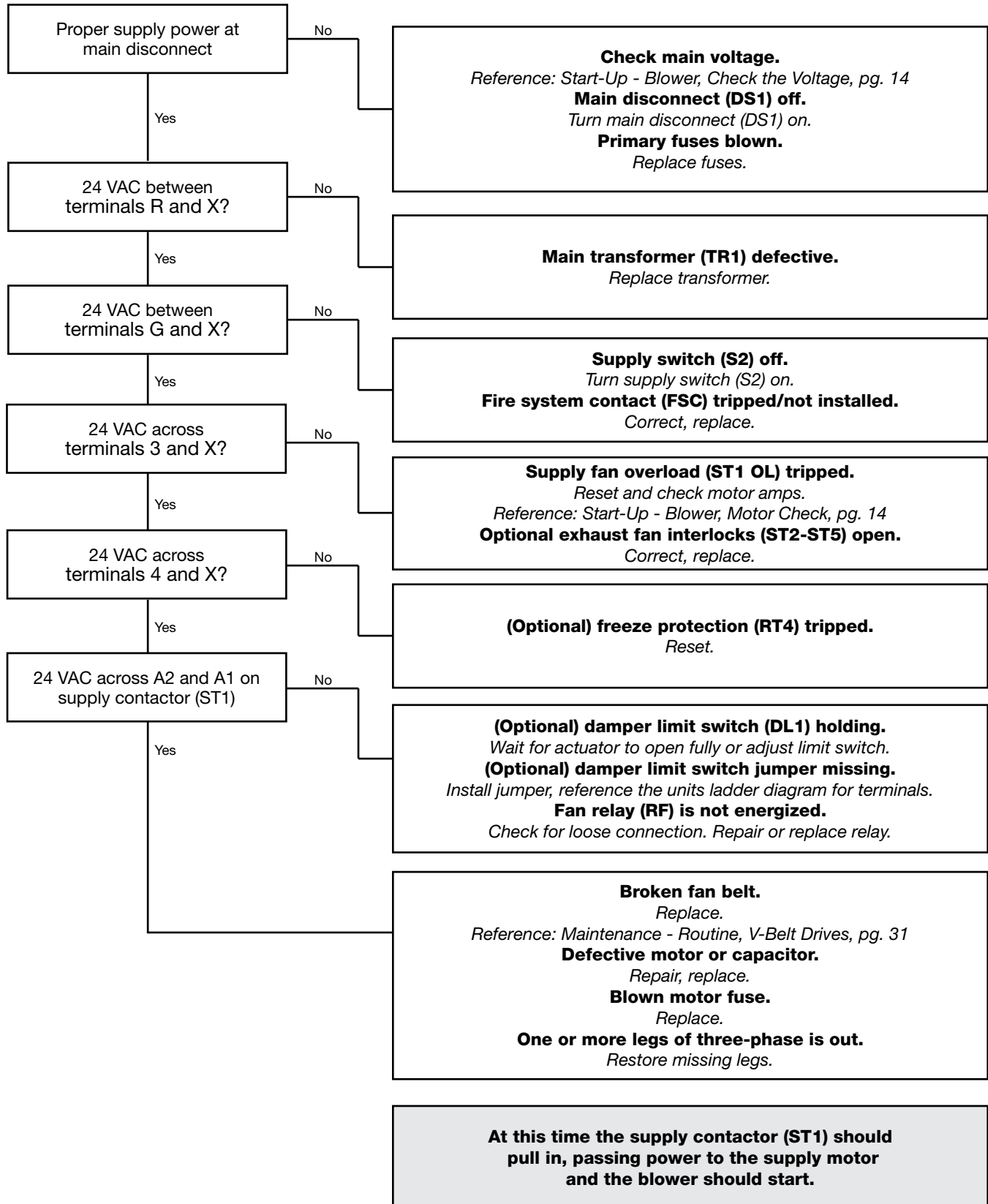

Troubleshooting

Motor Overamps

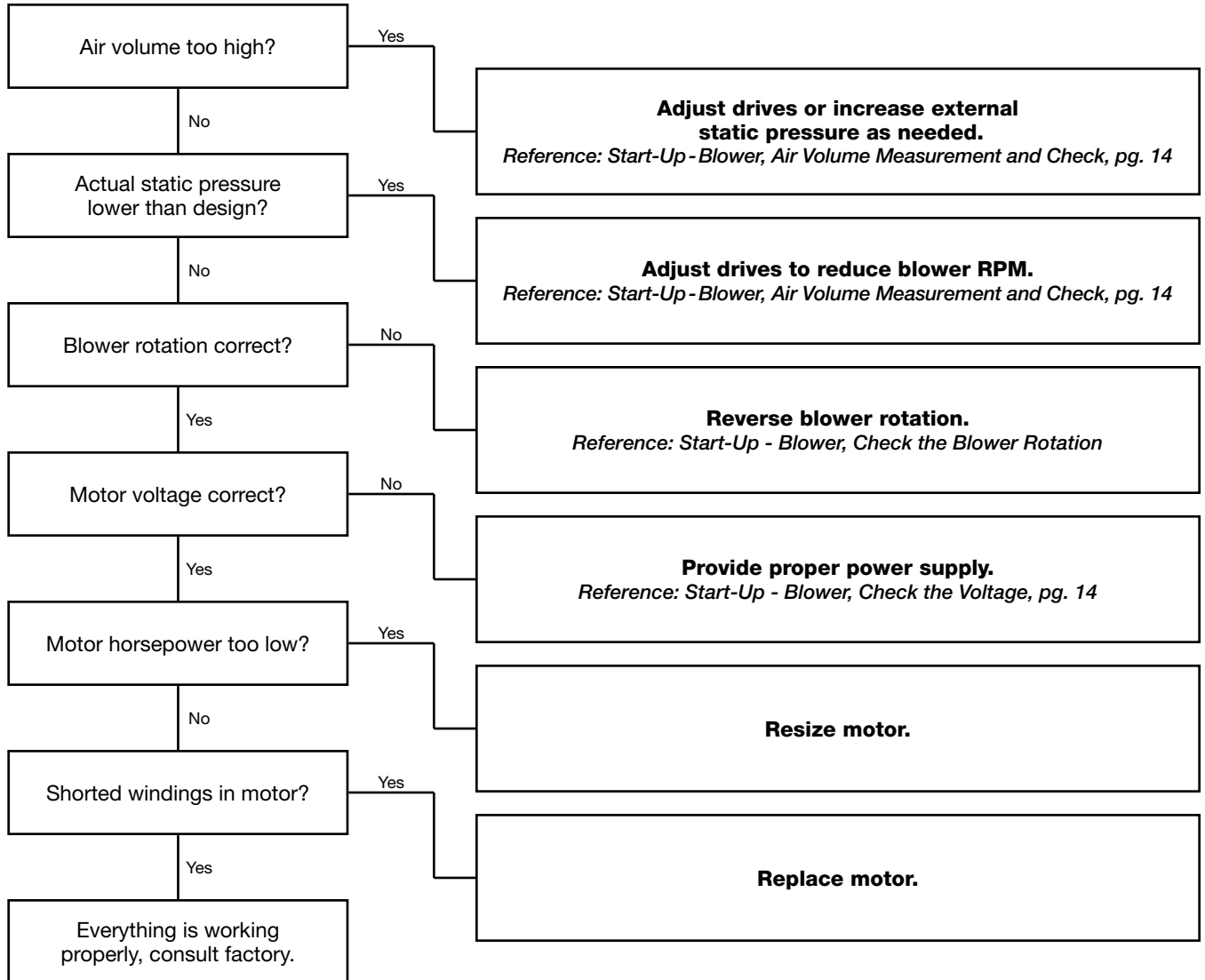

Troubleshooting

Insufficient Airflow

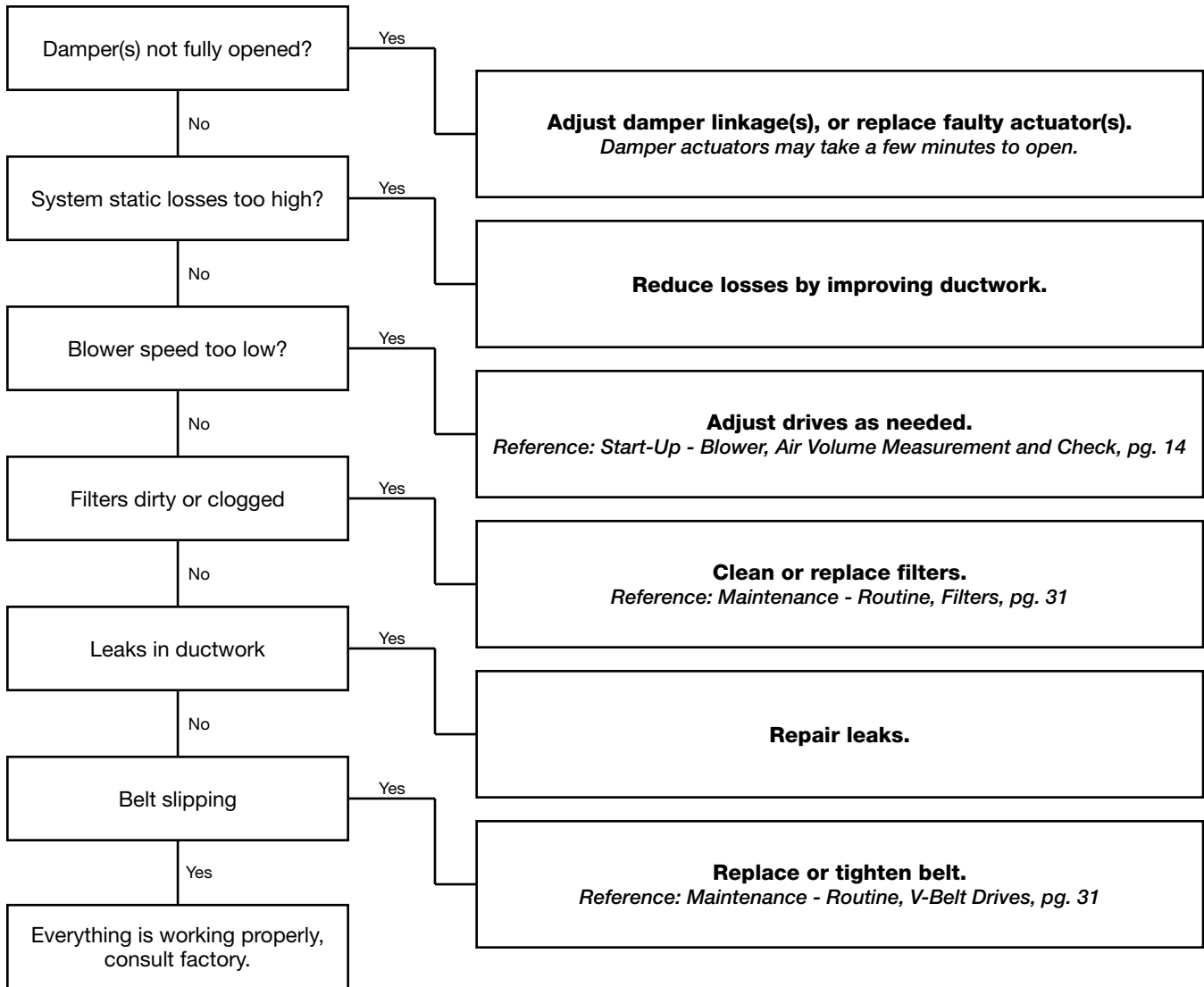

Too Much Airflow

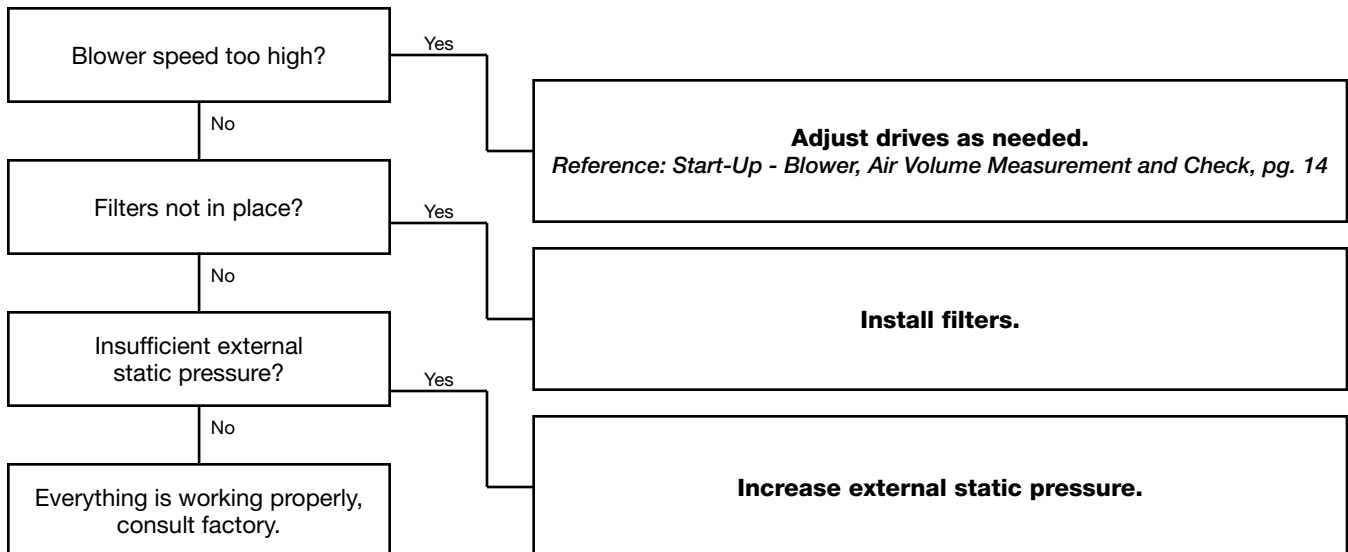

Troubleshooting

Excessive Noise or Vibration

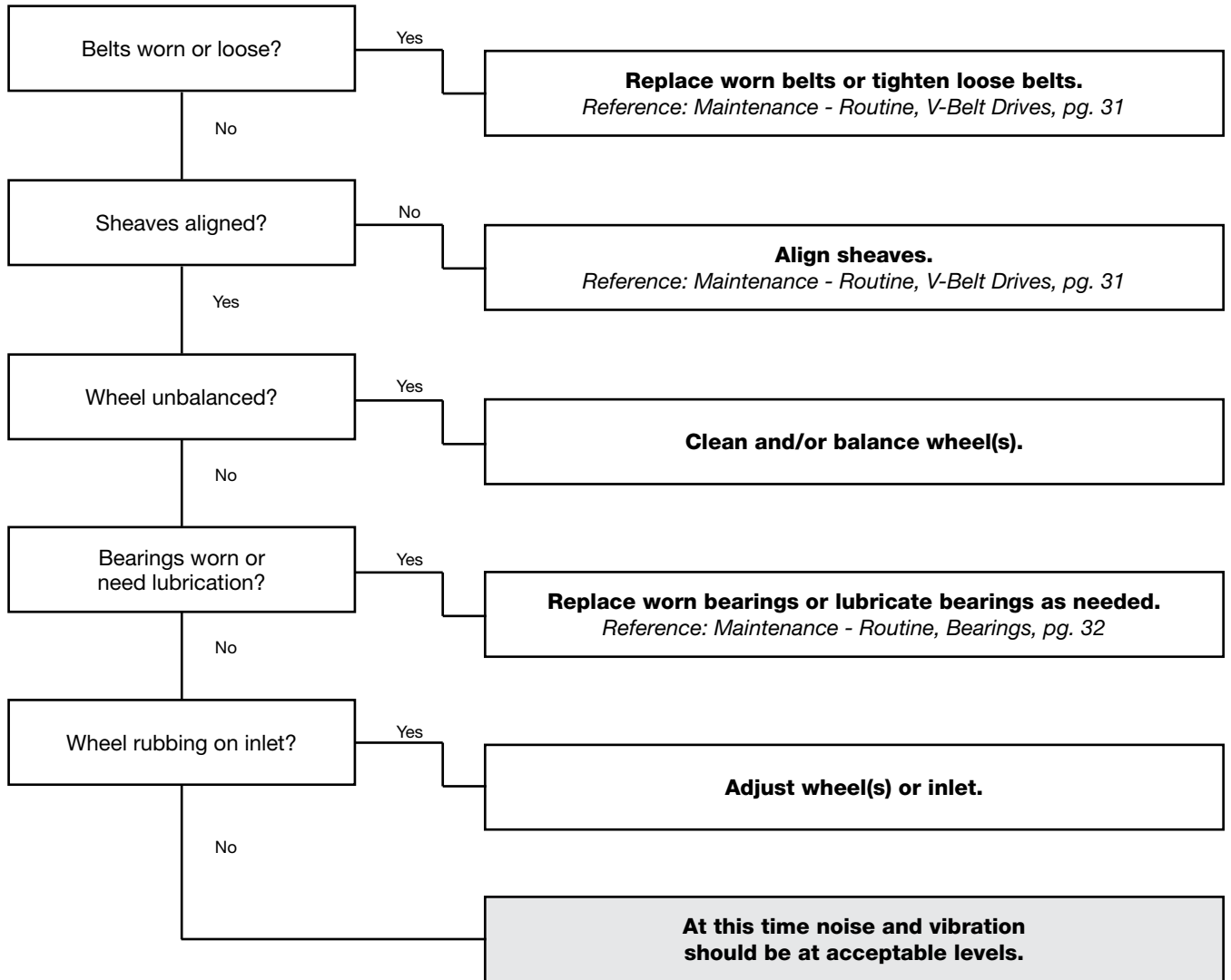

Troubleshooting

Heater Does Not Operate (Pilot Ignition)

Does not attempt to light (No visible spark)

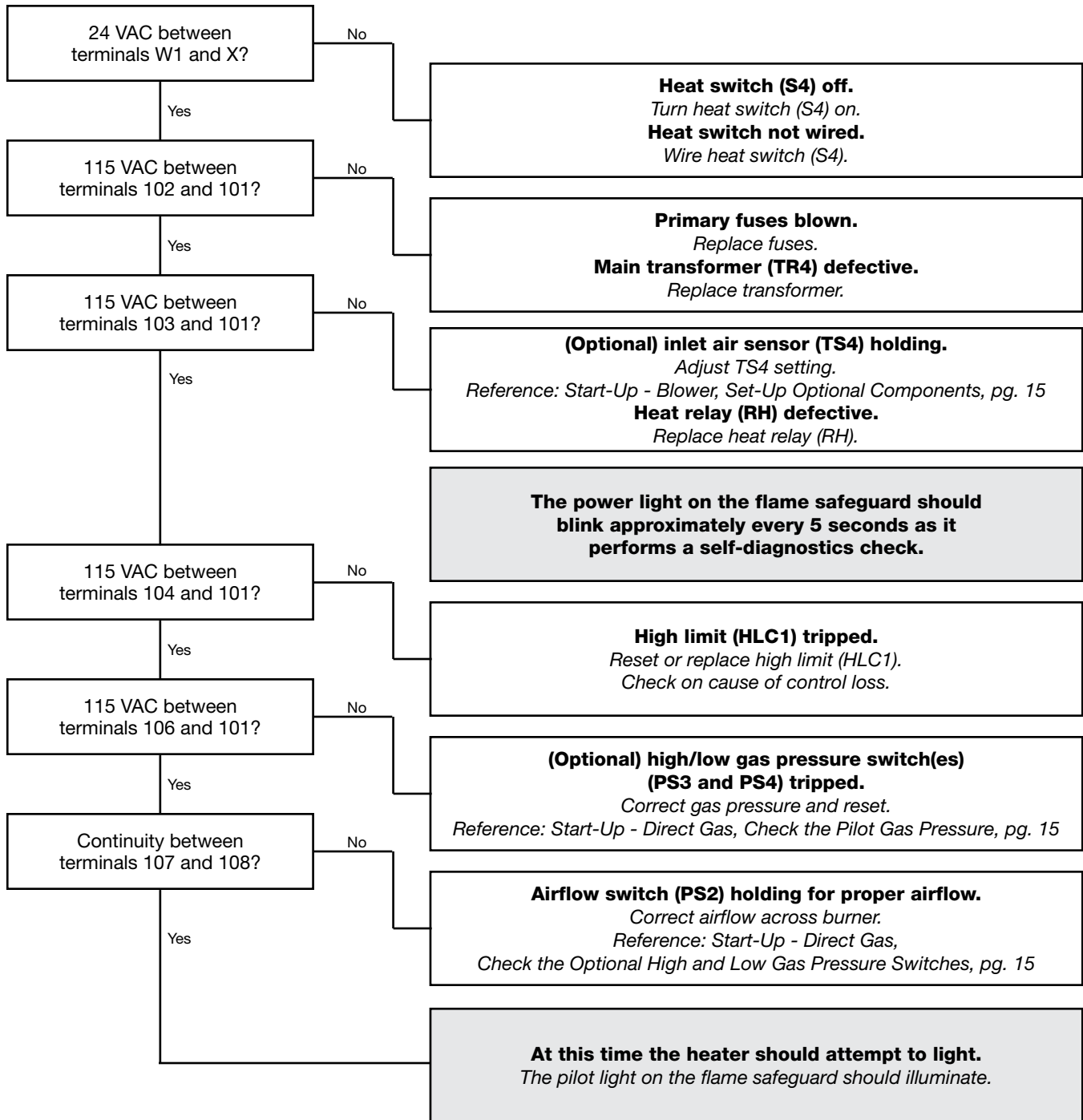

Troubleshooting

Heater Does Not Operate (Pilot Ignition)

Attempts to light, but no pilot (visible spark)

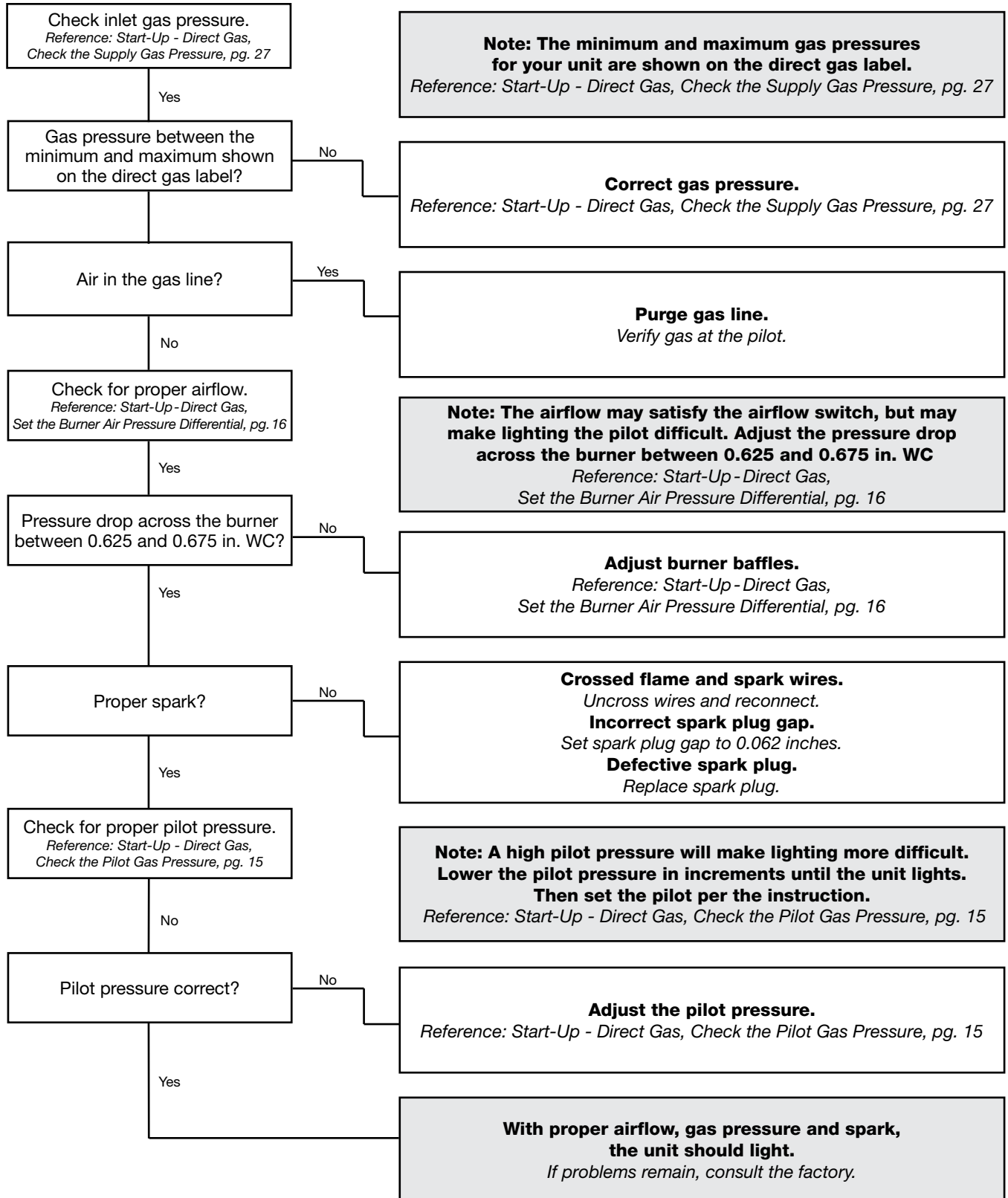

Troubleshooting

Heater Does Not Operate (Pilot Ignition)

Visible pilot

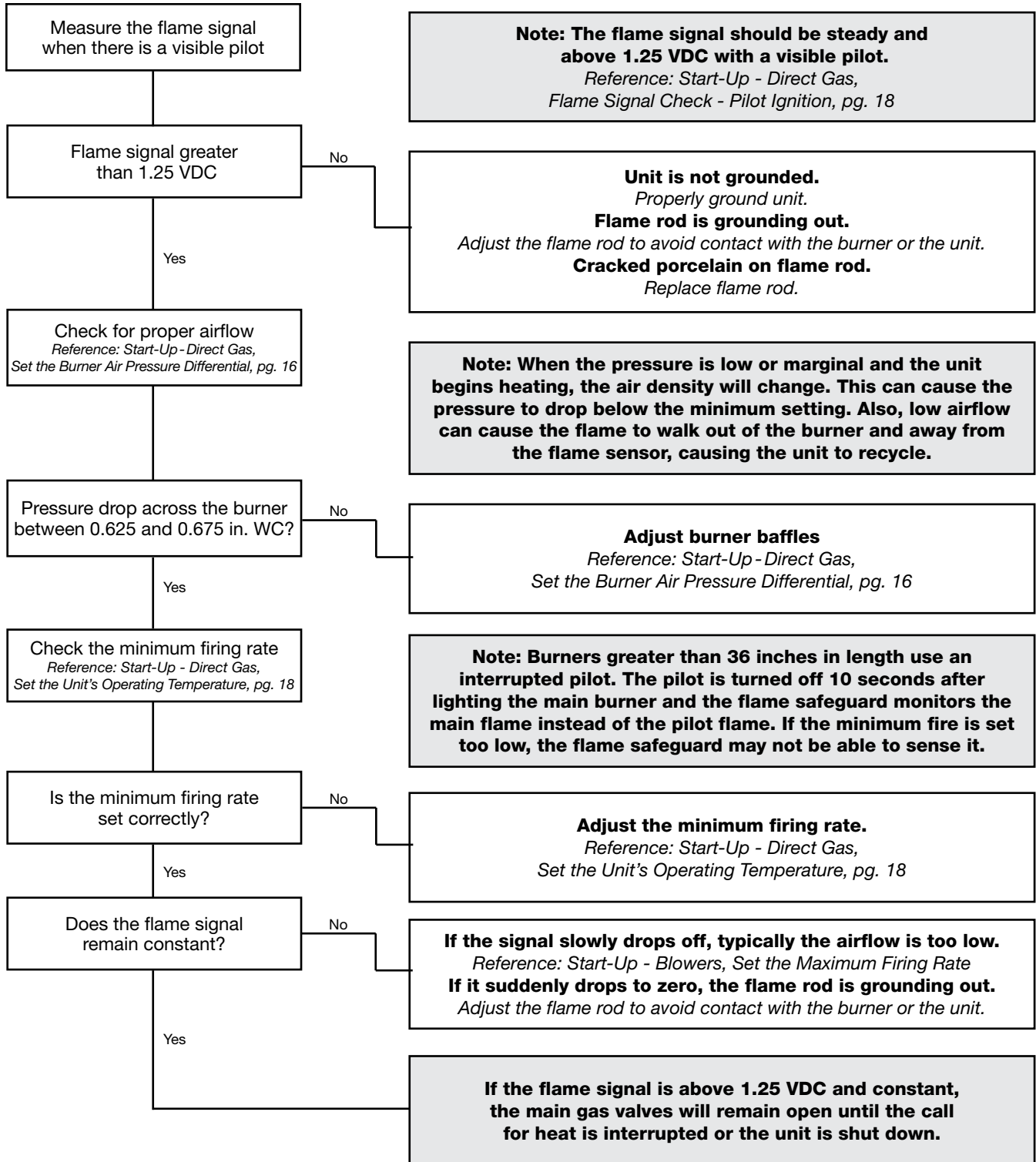

Troubleshooting

Heater Does Not Operate (Direct Spark)

Does not attempt to light (No visible spark)

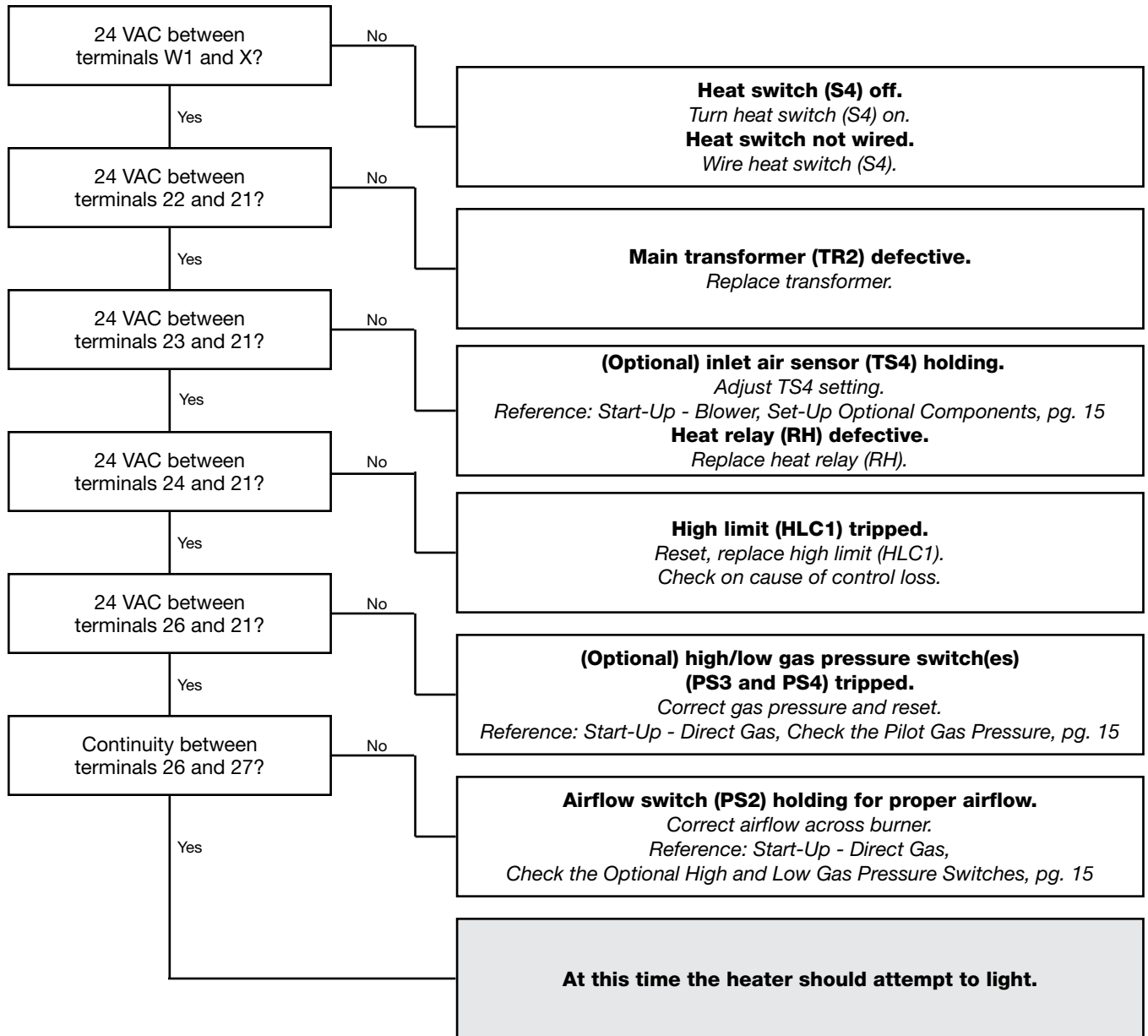

Troubleshooting

Heater Does Not Operate (Direct Spark)

Attempts to light, but no flame (Visible spark)

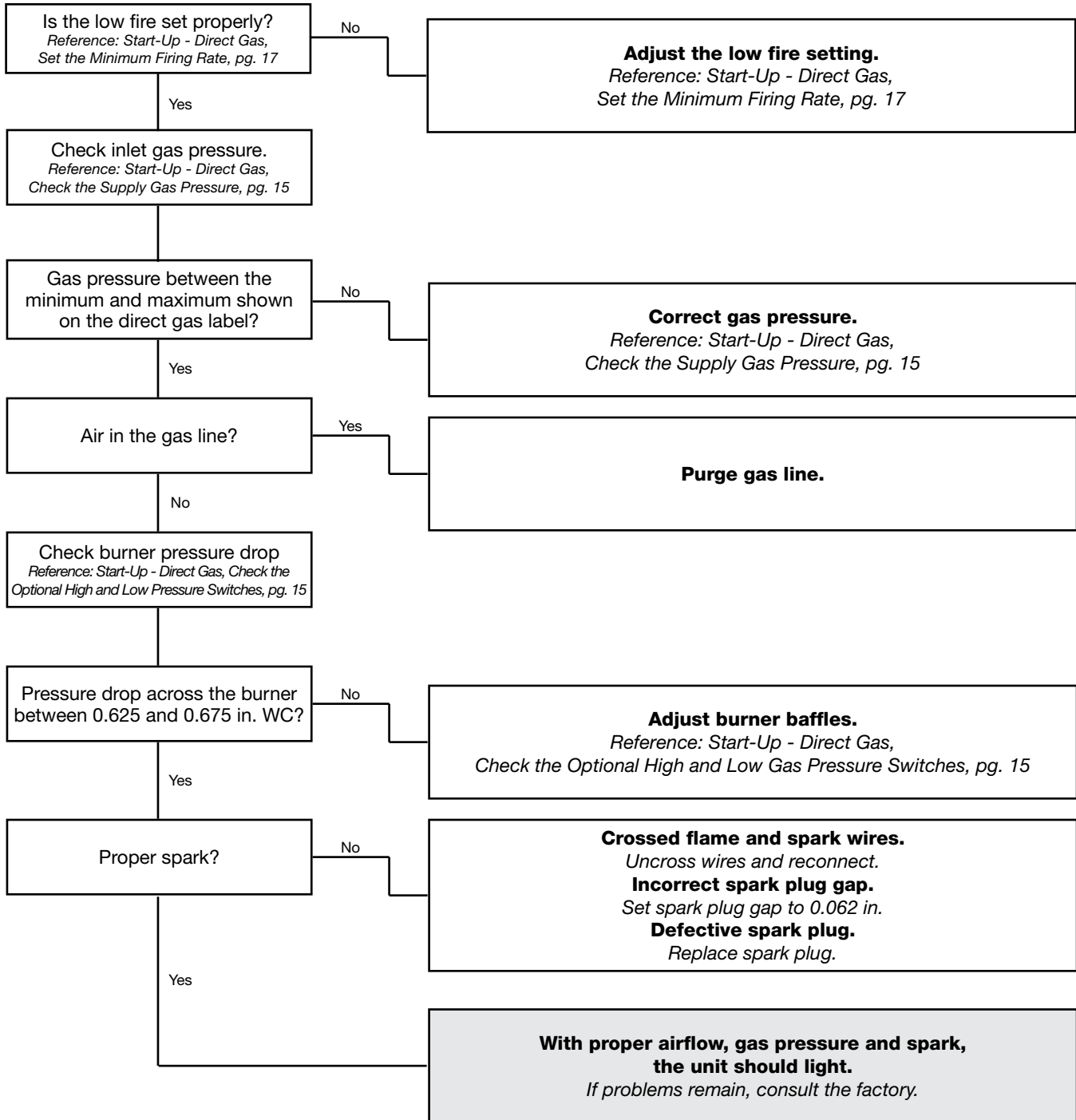

Maintenance - Routine

CAUTION

Lock-out the gas and the electrical power to the unit before performing any maintenance or service operations to this unit.

V-Belt Drives

V-belt drives must be checked on a regular basis for wear, tension, alignment, and dirt accumulation.

Check the tension by measuring the deflection in the belt as shown below.

Check the alignment by using a straight edge across both sheaves as shown below.

IMPORTANT

Premature or frequent belt failures can be caused by improper belt tension or misaligned sheaves.

- Abnormally high belt tension or drive misalignment will cause excessive bearing loads and may result in failure of the fan and/or motor bearings.
- Abnormally low belt tension will cause squealing on start-up, excessive belt flutter, slippage, and overheated sheaves.

IMPORTANT

Do not pry belts on or off the sheave. Loosen belt tension until belts can be removed by simply lifting the belts off the sheaves.

IMPORTANT

When replacing V-belts on multiple groove drives, all belts should be changed to provide uniform drive loading.

IMPORTANT

Do not install new belts on worn sheaves. If the sheaves have grooves worn in them, they must be replaced before new belts are installed.

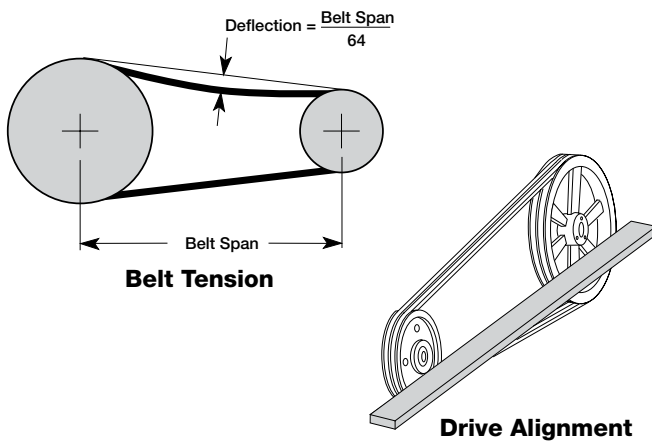

Motors

Motor maintenance is generally limited to cleaning and lubrication (where applicable).

Cleaning should be limited to exterior surfaces only. Removing dust and grease build-up on the motor assures proper motor cooling.

Motors supplied with grease fittings should be greased in accordance with the manufacturer's recommendations.

IMPORTANT

Do not allow water or solvents to enter the motor or bearings. Motors and bearings should never be sprayed with steam, water or solvents.

IMPORTANT

Greasing motors is only intended when fittings are provided. Many motors are permanently lubricated, requiring no additional lubrication.

Wheels

Wheels require little attention when moving clean air. Occasionally oil and dust may accumulate on the wheel causing imbalance. When this occurs the wheel and housing should be cleaned to assure proper operation.

Filters

Filter maintenance is generally limited to cleaning and replacement.

Aluminum mesh filters can be washed in warm soapy water.

An adhesive spray can be added to aluminum mesh filters to increase their efficiency.

IMPORTANT

When reinstalling filters, be sure to install them with the airflow in the correct direction. An airflow direction arrow is located on the side of the filters.

IMPORTANT

Replacement filters should be from the same manufacturer and the same size as the original filters provided with the unit.

Bearings

The bearings for the fans are carefully selected to match the maximum load and operating conditions of the specific class, arrangement and fan size. The instructions provided in this manual and those provided by the bearing manufacturer will minimize any bearing problems.

IMPORTANT

Lubricate bearings prior to periods of extended shutdowns or storage and rotate shaft monthly to aid in corrosion prevention. If the fan is stored more than three months, purge the bearings with new grease prior to start-up.

Recommended Bearing Lubrication Schedule (in Months*)

Fan RPM	Bearing Bore Size (inches)				
	½ - 1	1 ⅛ - 1 ½	1 ⅝ - 1 ⅞	1 15/16 - 2 3/16	2 7/16 - 3
750	6	5	4	3	3

*Suggested initial greasing interval is based on 12 hour per day operation and 150°F maximum housing temperature. For continuous (24 hour) operation, decrease greasing interval by 50%

- If extended grease lines are present, relubricate while in operation, only without endangering personnel.
- For ball bearings (operating) relubricate until clean grease is seen purging at the seals. Be sure not to unseat the seal by over lubricating.
- For ball bearings (idle) add 1-2 shots of grease up to 2 in. bore size, and 4-5 shots above 2 in. bore sizes with a hand grease gun.
- For roller bearings add 4 shots of grease up to 2 in. bore size, and 8 shots for 2-5 in. bore size with a hand grease gun.
- Adjust re lubrication frequency based on condition of purged grease.
- A high quality lithium based grease conforming to NLGI Grade 2 consistency, such as those listed here:

Mobil 532	Texaco Multifak #2	B Shell Alavania #2
Mobilux #2	Texaco Premium #2	Exxon Unirex #2

Maintenance - Fall

Start-Up

Repeat the information as outlined in:

- Start-Up - Blower (page 14)
 - Air Volume Measurement and Check
- Start-Up - Direct Gas (pages 15 and 16)
 - Check the Supply Gas Pressure
 - Check the Pilot Gas Pressure
 - Check the Optional High and Low Gas Pressure Switches
 - Set the Burner Air Pressure Differential

This will ensure that the gas and air are set properly before the heating season begins and should lead to trouble free operation all winter.

High Limit

The high limit switch may have tripped over the summer; it should be checked and reset if necessary.

Burner

Inspect the burner for accumulation of scales on both the upstream and downstream sides of the mixing plates. Any scaling or foreign material should be removed with a wire brush.

Visually check that all holes in the mixing plates are clear. If any burner ports are plugged (even partially), clear them with a piece of wire or another appropriate tool.

Replace or tighten any loose or missing fasteners on the mixing plates. Always use zinc-plated or stainless steel fasteners.

Inspect and clean the flame and spark rod. Occasional replacement of the flame rod and spark rod may be necessary to ensure optimum unit performance.

WARNING

Do not enlarge burner ports when clearing a blockage, performance could be affected.

NOTE

Flame rods can last many years, but because of thermal expansion of the porcelain, flame rods can fail over time.

Gas Train

The gas connections, joints and valves should be checked annually for tightness. Apply a soap and water solution to all piping; watch for bubbling which indicates a leak. Other leak testing methods can be used.

Reference

Typical Gas Train Layout with Modulating Valve (Pilot Ignition)

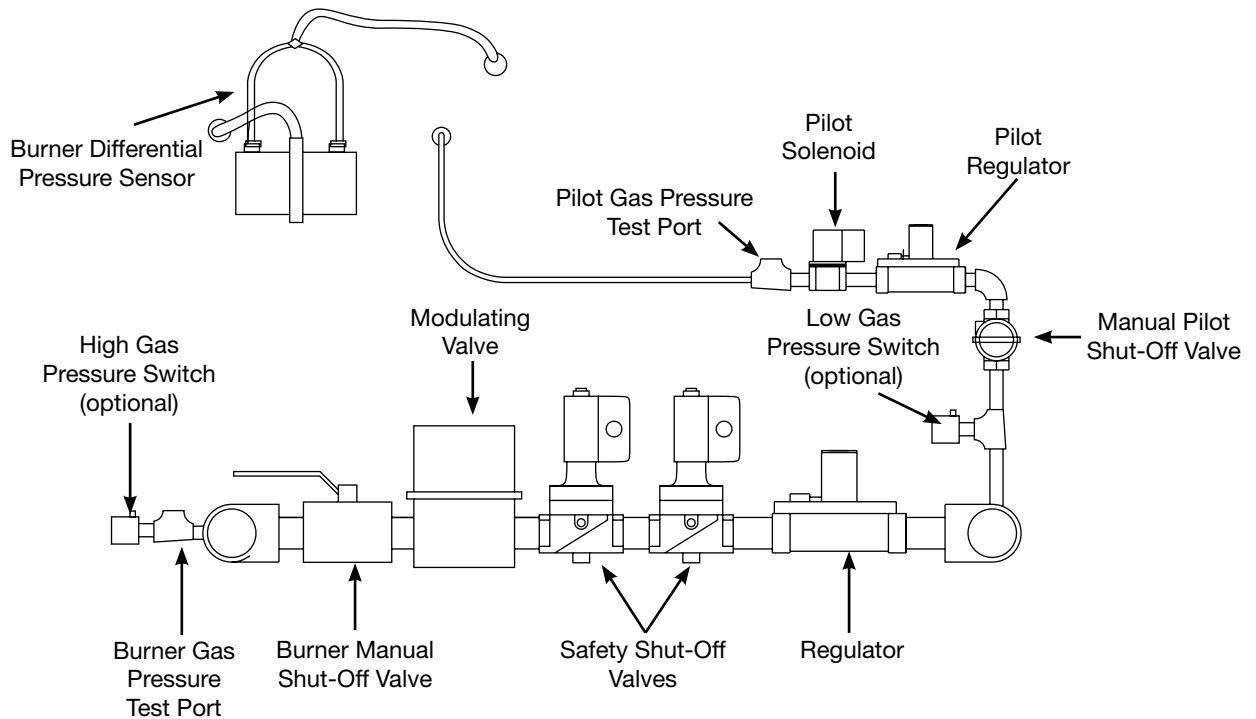

Typical Gas Train Layout with Modulating Regulator (Pilot Ignition)

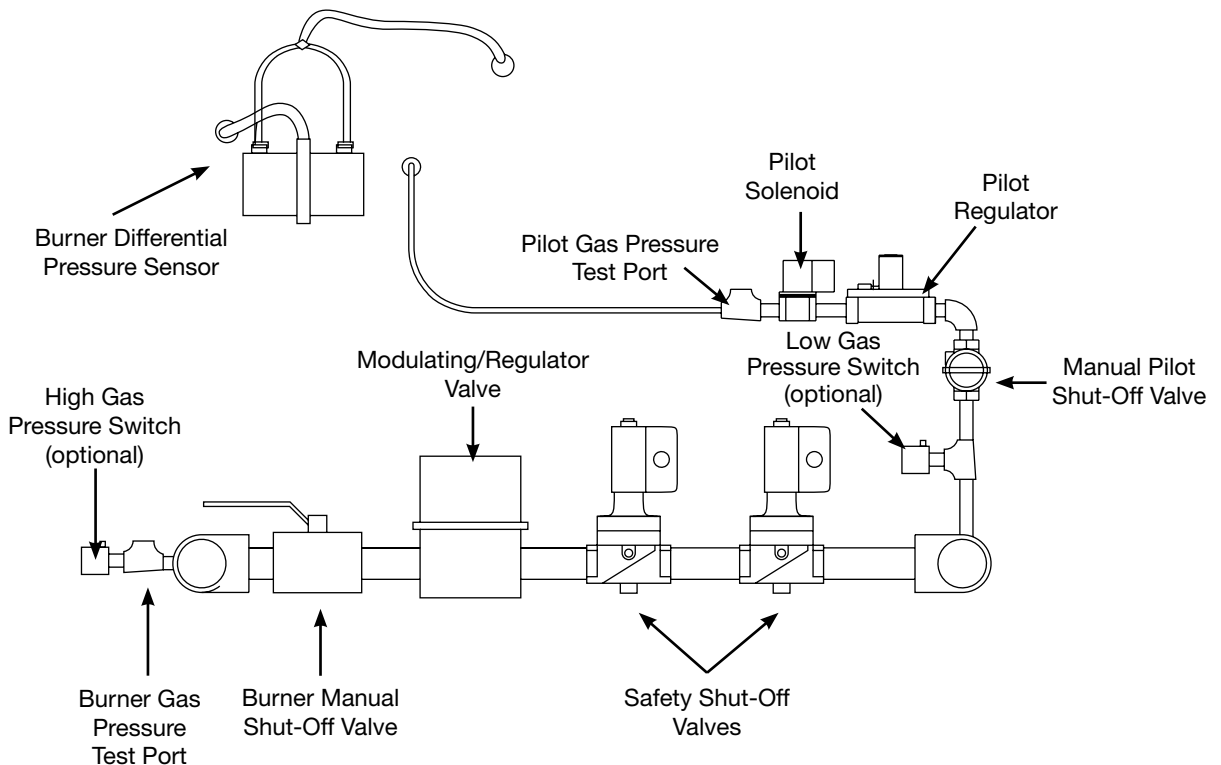

Reference

Typical Gas Train Layout with Direct Spark Ignition

This is a typical gas train. The gas train in your unit may be different.

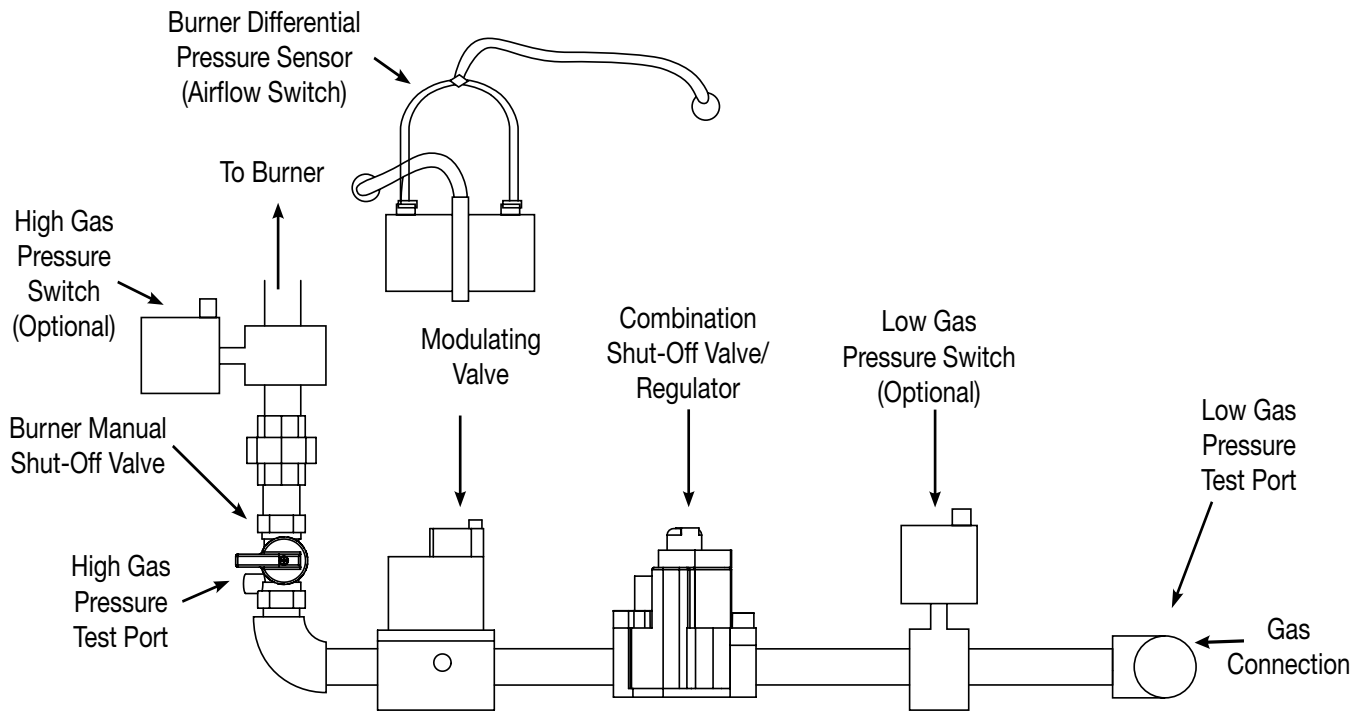

Reference

Control Center Layout

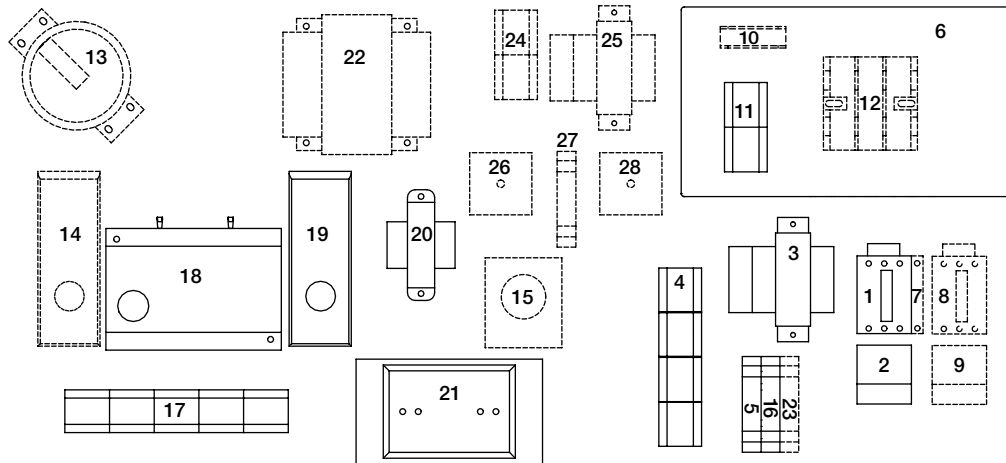

1. **Supply Motor Starter** — 24 volt magnetic contacts for starting supply motor.
2. **Supply Overload** — provides electronic overload protection to supply motor.
3. **Low Voltage Transformer** — provides low voltage to fan/heat/cooling enable controls.
4. **Control Terminal Block** — provides wiring access to controls.
5. **Fan Relay** — allows power to pass to energize motor starter.
6. **High Voltage Enclosure** — provides protection from high voltage circuits.
7. **Auxiliary Contact (optional)** — provides one normally closed and one normally open contact for other equipment.
8. **Exhaust Motor Starter (optional)** — 24 volt magnetic contacts for starting exhaust motor.
9. **Exhaust Overload (optional)** — provides electronic overload protection to exhaust motor.
10. **Transformer Fuse (optional)** — provides proper fusing for cooling transformer.
11. **Terminal Block** — provides wiring access to high voltage circuits.
12. **Exhaust Fuses (optional)** — provides proper fusing for exhaust fan motor(s).
13. **Dirty Filter Switch (optional)** — monitors filter pressure drop, turns on indicating light when pressure drop is above field adjustable set point.
14. **Inlet Air Sensor (optional)** — outdoor air stat that automatically controls the heating and/or cooling based on outdoor air temperature.
15. **Remote Temperature Selector (optional)** — allows for remote temperature set point.
16. **Heat Relay** — allows power to pass to heating controls.
17. **Heating Terminal Block** — provides wiring access to heating controls.
18. **Flame Safeguard/Spark Generator (Direct Spark)** — monitors flame, shuts down unit when unsafe conditions are detected.
19. **High Limit** — prevents unit from discharging air above a set point.
20. **Low Voltage Transformer** — reduces voltage to Maxitrol system.
21. **Amplifier** — controls modulating valve, assures the desired temperature is delivered.
22. **Transformer (optional)** — provides voltage to optional evaporative cooling pump.
23. **Cooling Relay (optional)** — allows power to pass to cooling controls.
24. **Cooling Terminal Block (optional)** — provides wiring access to cooling controls.
25. **Low Voltage Transformer (optional)** — reduces voltage to cooling controls.
26. **Reset Timer (optional)** — resets cooling system to run a time interval.
27. **Auto Drain Relay (optional)** — assures supply pump does not operate during drain interval. Allows pump to operate in cooling mode.
28. **Cooling Timer (optional)** — allows for automatic draining of the evaporative cooling system based on time schedule.

Dirty Filter Switch

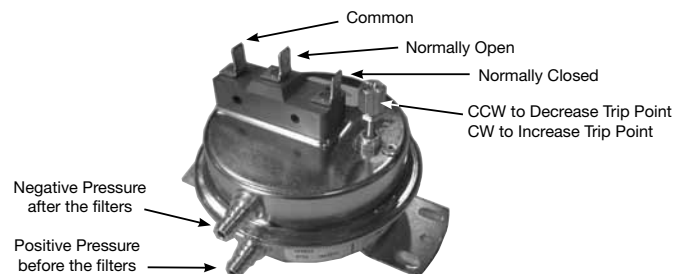

Maintenance Log

Date _____ Time _____ AM/PM

Notes: _____

Date _____ Time _____ AM/PM

Notes: _____

Date _____ Time _____ AM/PM

Notes: _____

Date _____ Time _____ AM/PM

Notes: _____

Date _____ Time _____ AM/PM

Notes: _____

Date _____ Time _____ AM/PM

Notes: _____

Warranty

Greenheck warrants this equipment to be free from defects in material and workmanship for a period of one year from the shipment date. Any units or parts which prove defective during the warranty period will be replaced at our option when returned to our factory, transportation prepaid. Motors are warranted by the motor manufacturer for a period of one year. Should motors furnished by Greenheck prove defective during this period, they should be returned to the nearest authorized motor service station. Greenheck will not be responsible for any removal or installation costs.

As a result of our commitment to continuous improvement, Greenheck reserves the right to change specifications without notice.

Greenheck's Model VSU catalog provides additional information describing the equipment, fan performance, available accessories, and specification data.

AMCA Publication 410-96, Safety Practices for Users and Installers of Industrial and Commercial Fans, provides additional safety information. This publication can be obtained from AMCA International, Inc. at: www.amca.org.



Phone: (715) 359-6171 • Fax: (715) 355-2399 • E-mail: gfcinfo@greenheck.com • Web site: www.greenheck.com